

VIBIA

Assembly instructions / Instrucciones de montaje / Montageanleitung
Istruzioni di montaggio / Instructions de montage

Algorithm

Design by Toan Nguyen



Caution

Before assembling and installing this product, carefully read the following:

- Switch of the mains power only, excluding the lamp.
- To install on the ceiling, always choose the most adequate fixing tools for the ceiling material.
- This lamp is for indoor use only, excluding bathrooms or any type of humid surface.
- We recommend reading the manual before installing the lamp. Keep this instructions for future reference.
- Do not disassemble, modify or try to repair this fitting. In order to get technical assistance contact VIBIA. Any change or modification to the light fitting can null the manufacturer's guarantee.
- All electronic products and batteries must be taken to separate waste collection points at the end of their working lives, they must not be disposed of in normal household waste. It is the responsibility of the user to dispose of the equipment using a designated collection point or service for separate recycling of waste electrical and electronic equipment (WEEE) and batteries according to local laws.
- Use these gloves to touch the lamp during the installation to avoid smudges and dirt on its surface.

Precaución

Antes de proceder al montaje e instalación de esta luminaria, leer detenidamente las siguientes consideraciones:

- Desconectar el suministro eléctrico antes de proceder a la instalación de la luminaria.
- Para el montaje de la luminaria al techo elegir los elementos de fijación más adecuados en función del soporte de instalación.
- Esta luminaria es apta únicamente para su uso en interior, excepto en baños o cualquier tipo de superficie húmeda.
- Recomendamos leer el manual antes de iniciar la instalación de la luminaria. Guardar estas instrucciones para futuras consultas.
- No desmonte, modifique, ni intente reparar la luminaria. Para recibir asistencia técnica, póngase en contacto con VIBIA. Cualquier cambio o modificación en la luminaria puede anular la garantía del fabricante.
- Todos los productos electrónicos y las baterías deben llevarse a puntos de recolección de residuos separados cuando finalicen sus ciclos de vida, no se deben desechar en la cadena normal de residuos con la basura doméstica. Es responsabilidad del usuario desechar los dispositivos en un punto o servicio de recolección designado para el reciclaje separado de residuos de aparatos eléctricos y electrónicos (WEEE), así como las baterías, de conformidad con las leyes locales.
- Utilice estos guantes para manipular la luminaria durante el montaje y evitar un posible trasvase de suciedad de sus manos.

Vorsicht

Bevor Sie mit der Montage dieser Leuchte beginnen, sollten Sie die folgenden Hinweise in aller Ruhe lesen und berücksichtigen:

- Schalten Sie vor dem elektrischen Anschluss den Strom ab.
- Wählen Sie passend zu der Vorrichtung für die Deckenmontage der Leuchte das dafür geeignetste Befestigungsmaterial.
- Diese Leuchte ist ausschliesslich für den Gebrauch im Innenbereich vorgesehen, ausser Bädern oder anderen Feuchträumen.
- Wir empfehlen vor Montagebeginn die Anleitung zu lesen. Bewahren Sie die Anleitung für etwaige zukünftige Fragen auf.
- Die Leuchte nicht auseinanderbauen, baulich ändern oder reparieren. Für technische Hilfe VIBIA kontaktieren. Eigenmächtig vorgenommene Änderungen an der Leuchte führen zu einem Verlust der Garantie.
- Alle elektronischen Produkte und Batterien am Ende Ihrer Lebensdauer getrennt entsorgt werden müssen, sie dürfen nicht über den normalen Fluss des Haushaltsmülls entsorgt werden. Es unterliegt der Verantwortlichkeit des Benutzers, die Ausrüstung unter Verwendung einer ausgewiesenen Sammelstelle oder eines Dienstes für getrenntes Recycling von elektrischen oder elektronischen Geräten und Batterien entsprechend der Gesetze vor Ort zu entsorgen (WEEE = Waste of Electrical and Electronic Equipment = Elektro - und Elektronikgeräte - Abfall).
- Benutzen Sie diese Handschuhe während der Montage, um keinen Schmutz der Hände auf die Leuchte zu übertragen.

Attention

Prima di procedere al montaggio e all'installazione di questo apparecchio, leggere attentamente le seguenti considerazioni:

- Scollegare l'alimentazione prima di procedere all'installazione dell'apparecchio.
- Per il montaggio della lampada al soffitto, usare gli strumenti di fissaggio più adeguati in base alla superficie di installazione.
- Questo apparecchio è adatto solo per uso interno, ad eccezione dei bagni o di qualsiasi tipo di superficie bagnata.
- Si consiglia di leggere il manuale prima di iniziare l'installazione dell'apparecchio. Salva queste istruzioni per future consultazioni.
- Non smontare, modificare né cercare di riparare la lampada. Per richiedere assistenza tecnica, mettersi in contatto con VIBIA. Qualsiasi cambiamento o modifica alla lampada può annullare la garanzia del fabbricante.
- Tutti i prodotti elettronici e le batterie devono essere separate in punti di raccolta del rifiuto una volta terminato l'utilizzo, non devono essere smaltiti nel normale flusso dei rifiuti insieme ai rifiuti domestici. È responsabilità dell'utente smaltire l'apparecchiatura utilizzando un punto di raccolta o un servizio per il riciclo di rifiuti di apparecchiature elettriche ed elettroniche (RAEE) e batterie secondo le leggi vigenti.
- Indossare i guanti inclusi nella confezione per maneggiare la lampada durante il montaggio ed evitare di contaminare la superficie.

Attenzione

Avant de procéder à l'assemblage et à l'installation de ce luminaire, lisez attentivement les considérations suivantes:

- Débranchez l'alimentation avant de procéder à l'installation du luminaire.
- Pour fixer le luminaire au plafond, utilisez les éléments de fixation les mieux adaptés au support.
- Ce luminaire ne convient que pour une utilisation en intérieur, sauf dans les salles de bains ou tout type de surface humide.
- Nous vous recommandons de lire le manuel avant de commencer l'installation du luminaire. Sauvegardez ces instructions pour futures consultations.
- Ne démontez pas le luminaire, ne le modifiez pas et n'essayez pas de le réparer. Pour bénéficier d'une assistance technique, contactez VIBIA. Toute altération ou modification du luminaire peut annuler la garantie du fabricant.
- Tous les produits électroniques et toutes les batteries doivent être apportés à des points de collecte distincts de ceux des ordures ménagères normales lorsqu'ils arrivent en fin de vie. Il incombe à l'utilisateur de se débarrasser de l'équipement dans un point de collecte ou auprès d'un service spécifiquement désigné pour le recyclage des déchets électriques et des équipements électroniques (DEEE) ainsi que des batteries, dans le respect de la législation locale.
- Lors du montage, manipulez ce luminaire à l'aide des gants fournis pour éviter toute trace de doigts.





Step 1
Product Spec Sheet



Step 2
Supplied Materials



Step 3
Installation Preparation



Step 4
Electrical Connection



Step 5
Product Assembly



Step 6
Adjustments & maintenance



Step 1/6 Product Spec Sheet

Technical specifications / Especificaciones técnicas / Technische Daten
Specifiche tecniche / Caractéristiques techniques

0827

Net Weight / Peso Neto / Netto-Gewicht / Peso netto / Poids net 10,5 Kg.  10 x LED 3,15W 1050mA.  **IP20** **Bi-volt**   ~ 50/60 Hz

0832

Net Weight / Peso Neto / Netto-Gewicht / Peso netto / Poids net 5,8 Kg.  6 x LED 3,15W 1050mA.  **IP20** **Bi-volt**   ~ 50/60 Hz

0857

Net Weight / Peso Neto / Netto-Gewicht / Peso netto / Poids net 5,8 Kg.  5 x LED 3,15W 1050mA.  **IP20** **Bi-volt**   ~ 50/60 Hz

0862

Net Weight / Peso Neto / Netto-Gewicht / Peso netto / Poids net 11,9 Kg.  13 x LED 3,15W 1050mA.  **IP20** **Bi-volt**   ~ 50/60 Hz

0867

Net Weight / Peso Neto / Netto-Gewicht / Peso netto / Poids net 20,3 Kg.  24 x LED 3,15W 1050mA.  **IP20** **Bi-volt**   ~ 50/60 Hz

0872

Net Weight / Peso Neto / Netto-Gewicht / Peso netto / Poids net 13,8 Kg.  15 x LED 3,15W 1050mA.  **IP20** **Bi-volt**   ~ 50/60 Hz

0882

Net Weight / Peso Neto / Netto-Gewicht / Peso netto / Poids net 11,4 Kg.  12 x LED 3,15W 1050mA.  **IP20** **Bi-volt**   ~ 50/60 Hz



Class I. Product with an additional protection cable (grounds).

Clase I. Aparato con un cable protector adicional (toma de tierra).

Klasse I. Apparat mit zusätzlichen Schutzleiter (Erdkabel).

Classe I. Apparecchio con un cavo di protezione aggiuntivo (presa di terra).

Classe I. Appareil avec câble d'isolation additionnel (borne de terre).

IP20

Product protected against solid object as big as or bigger than 12 mm. No protection against water.

Producto protegido contra la penetración de cuerpos sólidos de tamaño igual o superior a 12mm. Sin protección al agua.

Produkt ist geschützt gegen das Eindringen von Fremdkörpern >12mm. Kein Schutz gegen Eindringen von Wasser.

Prodotto protetto contro la penetrazione di corpi solidi di dimensioni pari o superiori a 12 mm. Non protetto dall'acqua.

Produit protégé contre les intrusions de corps solides de taille égale ou supérieure à 12 mm. Non protégé contre l'eau.

Bi-volt

Rango de voltaje:

Voltage range:

Spannungsbereich:

Campo di tensione:

Gamme de tension:

100-240V



Alternating current.

Corriente alterna.

Wechselstrom.

Corrente alternata

Courant alternatif.



Step 2/6

Supplied Materials

Supplied material / Material suministrado / Geliefertes Material
Materiale incluso / Matériel fourni

	0827	0832	0857	0862	0867	0872	0882
1. Components Bag / Bolsa componentes / Tütchen mit Teilen Sacchetto componenti / Sachet d'accessoires	1 un.	1 un.	1 un.	1 un.	2 un.	1 un.	1 un.
2. Allen key / Llave allen / Inbusschlüssel / Chiave a brugola Clé Allen	1 un.	1 un.	1 un.	1 un.	1 un.	1 un.	1 un.
3. Microfiber Cloth / Paño Microfibra / Mikrofasertuch Panno in microfibra / Chiffon microfibres	1 un.	1 un.	1 un.	1 un.	1 un.	1 un.	1 un.
4. Gloves / Guantes / Handschube / Guanti / Gants	1 un.	1 un.	1 un.	1 un.	1 un.	1 un.	1 un.
5. Ceiling rose / Florón / Deckenteller / Rosone a soffitto Pavillon	1 un.	1 un.	1 un.	1 un.	1 un.	1 un.	1 un.
6. Junction box / Caja de conexión / Anschlussbox Scatola di giunzione / Boîte de dérivation	1 un.	1 un.	1 un.	1 un.	-	1 un.	1 un.
7. Double junction box / Caja conexión doble / Doppel-Anschlussbox Scatola di giunzione doppio / Boîte de dérivation double	-	-	-	-	1 un.	-	-
8. Single cable / Cable individual / Einzelkabel / Cavo singolo Câble unique	1 un.	1 un.	1 un.	1 un.	-	1 un.	1 un.
9. Double cable / Cable doble / Doppelkabel / Doppio cavo / Double câble	-	-	-	-	1 un.	-	-
10. Rods / Barras / Gestänge / Aste / Tige	3 un.	2 un.	4 un.	4 un.	4 un.	4 un.	6 un.
11. Lighting fixture / Estructura luminaria / Leuchten-Struktur Struttura lampada / Structure du luminaire	1 un.	1 un.	1 un.	1 un.	1 un.	1 un.	1 un.
12. Globe diffuser assembly / Conjunto bola Difusor Diffusor-Kugel / Set diffusore a sfera / Ensemble diffuseur boule	10 un.	6 un.	5 un.	13 un.	25 un.	15 un.	12 un.
13. Template / Plantilla / Schablone / Modello / Modèle	1 un.	1 un.	1 un.	1 un.	1 un.	1 un.	1 un.



Step 2/6

Supplied Materials

Supplied material / Material suministrado / Geliefertes Material
Materiale incluso / Matériel fourni

1



2



3



4



5



6

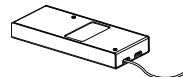

7

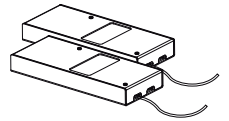

8



9



10



11

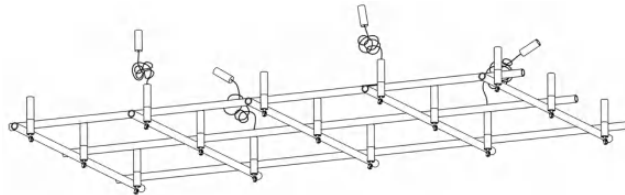

12

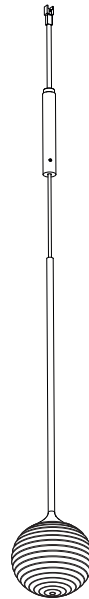

13





Step 3/6 Installation Preparation

OPTION A

- WITH STEEL TENSION CABLES
- CON TENSORES DE ACERO
- MIT SPANNSCHRAUBEN

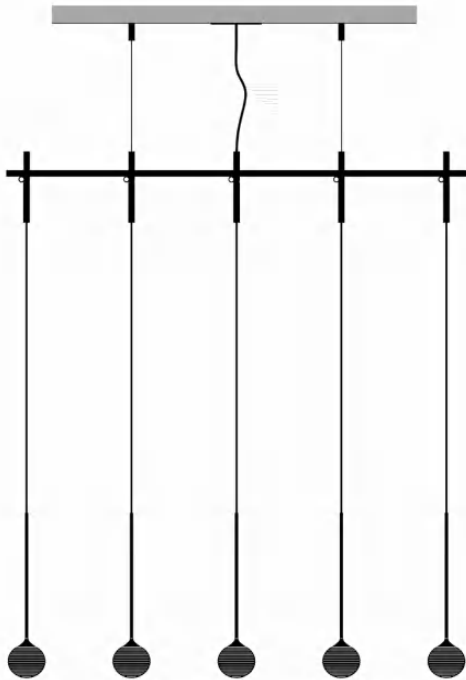
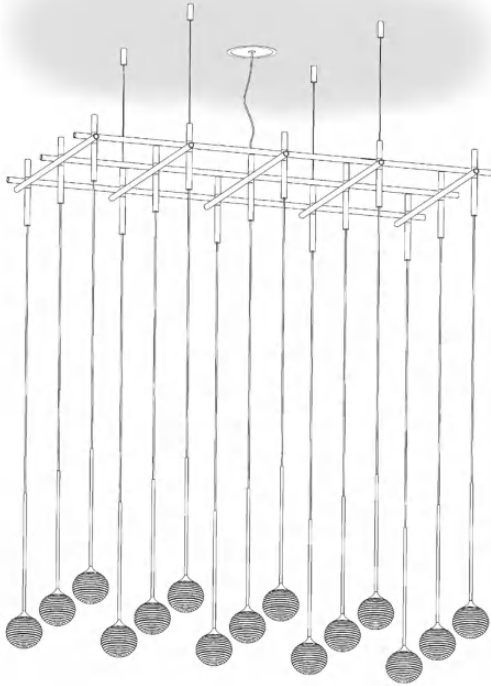

OPTION B

- WITH RODS
- CON BARRAS
- MIT STANGEN

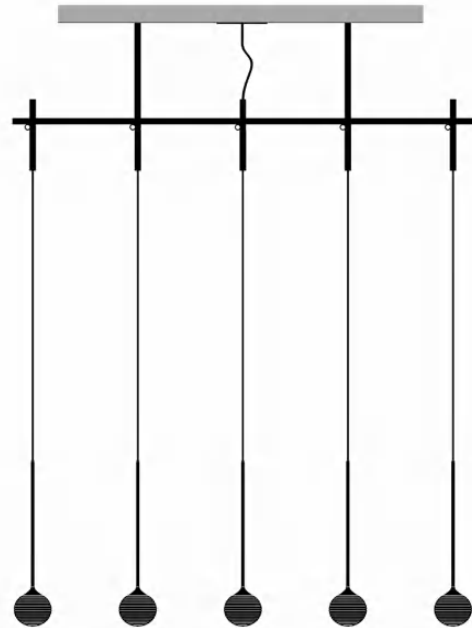
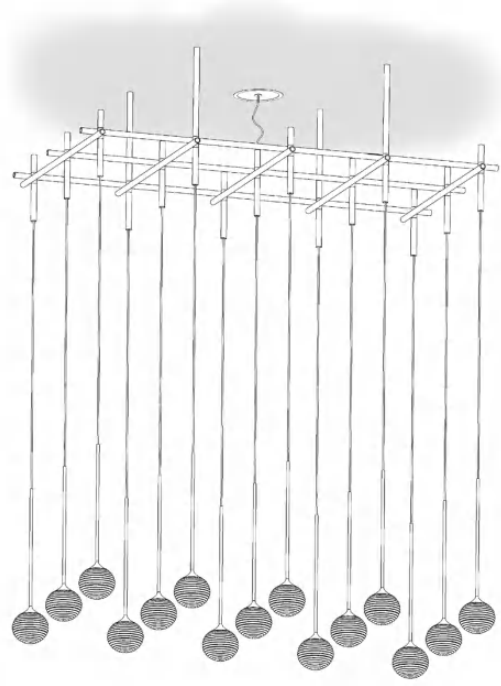



Step 3/6

Installation Preparation

Installation with the steel tension cables / Instalación con tensores de acero
Montage Mit Spannschrauben / Installazione con i cavi di tensione / Installation avec les câbles de tension

OPTION A

3.1a

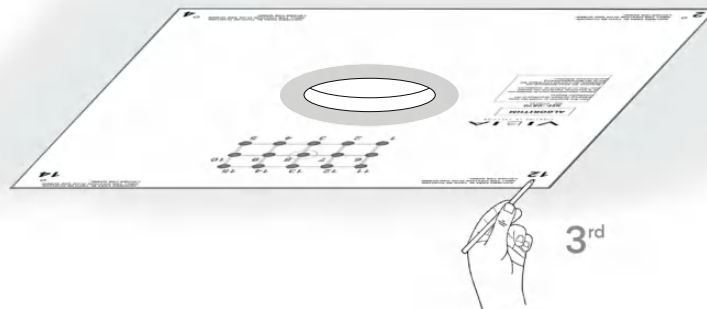
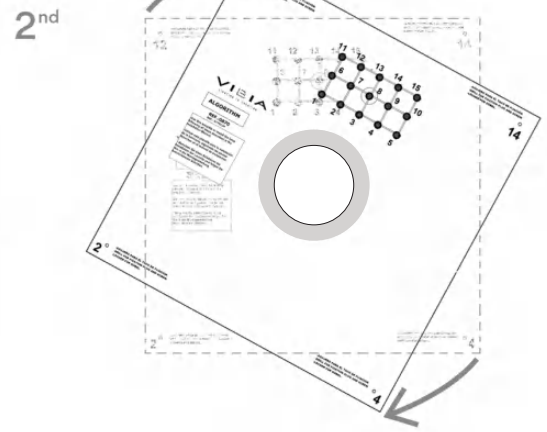
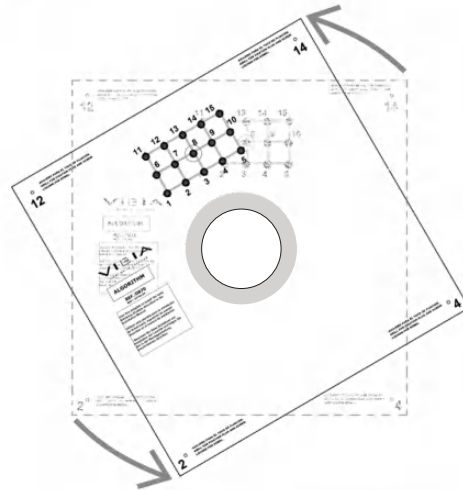
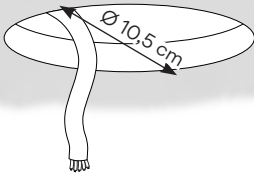
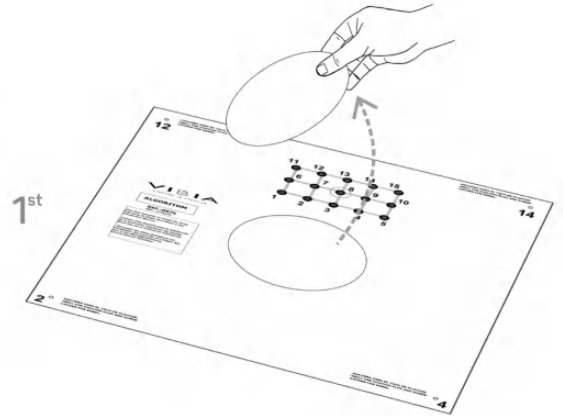
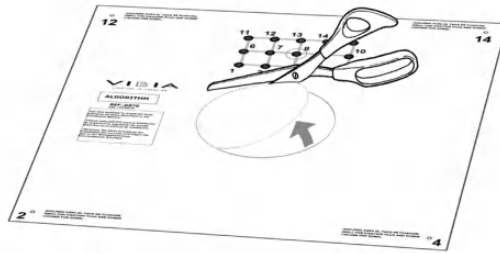



Step 3/6 Installation Preparation

3.2a

Ref. 0827

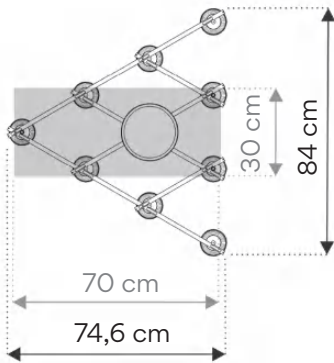

Ref. 0857

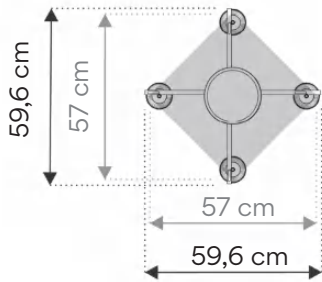

Ref. 0867

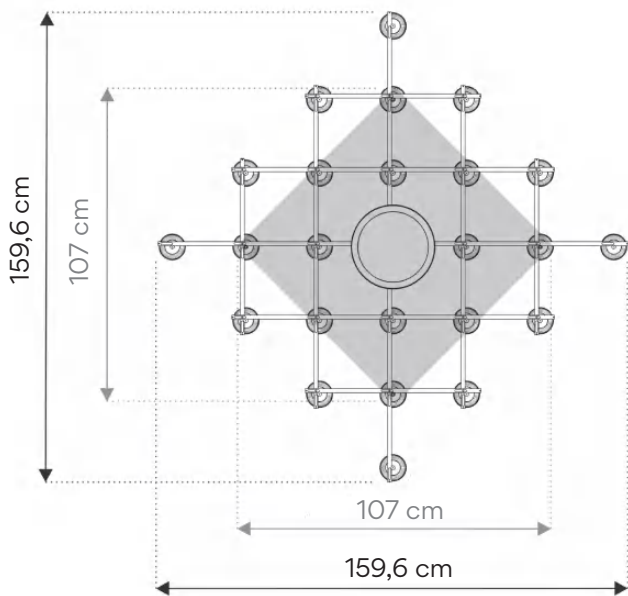

Ref. 0832

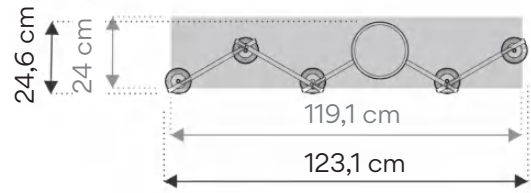

Ref. 0862

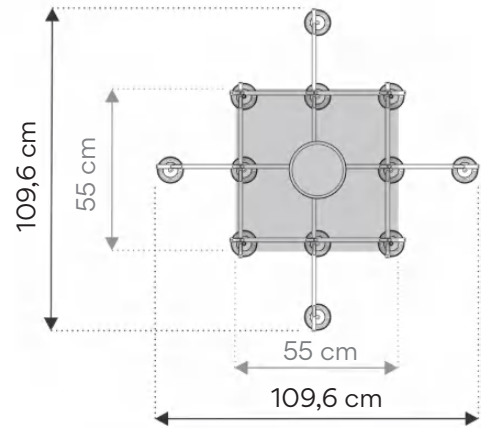

Ref. 0872

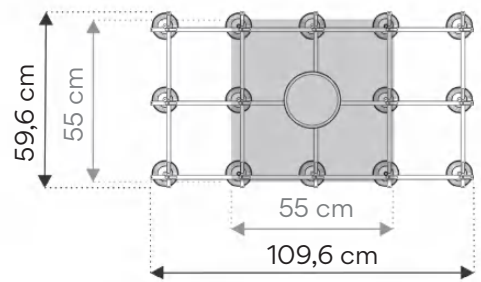

Ref. 0887

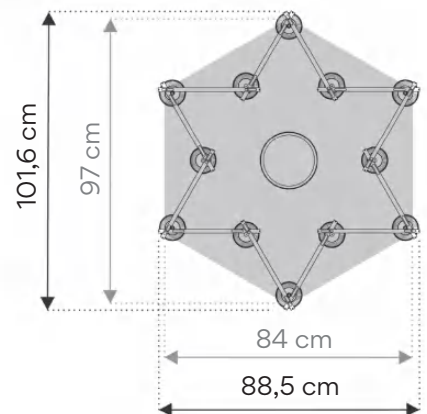



Step 3/6 Installation Preparation

3.3a

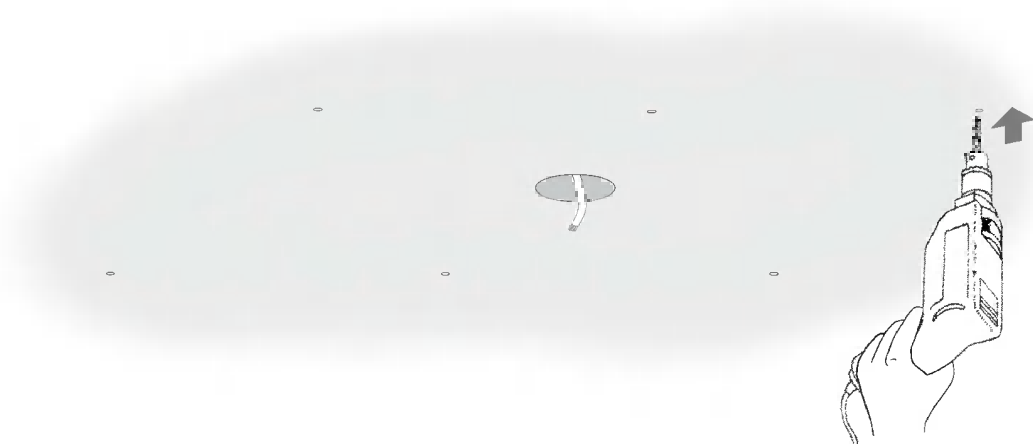

3.4a

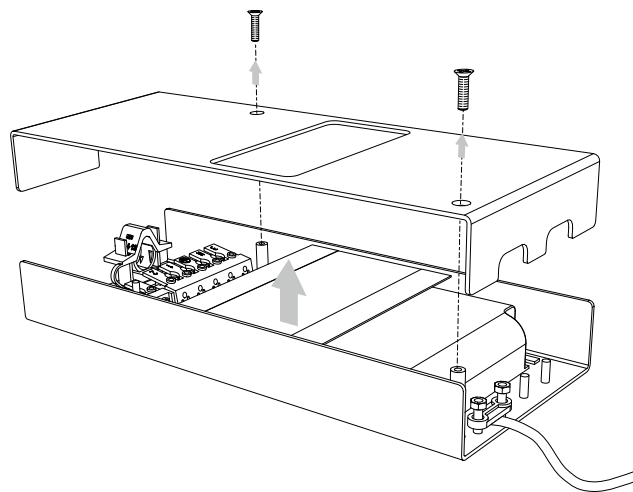

Ref. 0867

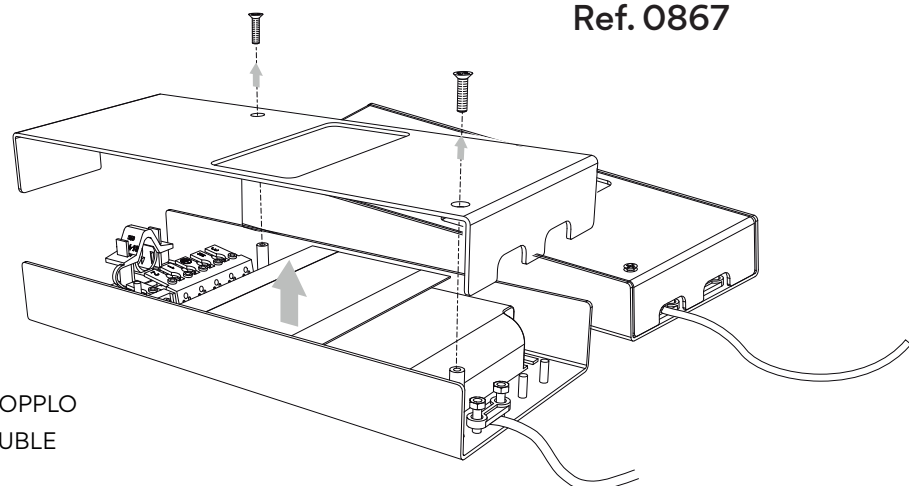

- DOUBLE JUNCTION BOX
- CAJA CONEXIÓN DOBLE
- DOPPEL-ANSCHLUSSBOX
- SCATOLA DI GIUNZIONE DOPPIO
- BOÎTE DE DÉRVATION DOUBLE



Step 4/6 Electrical Connection

4.1a

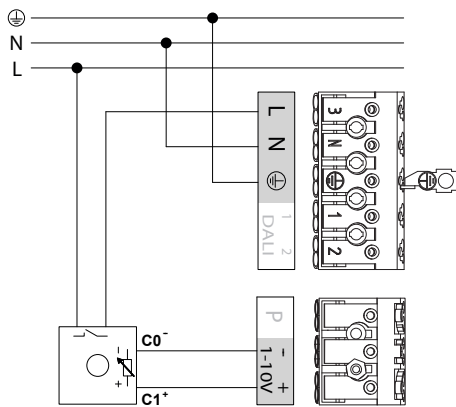
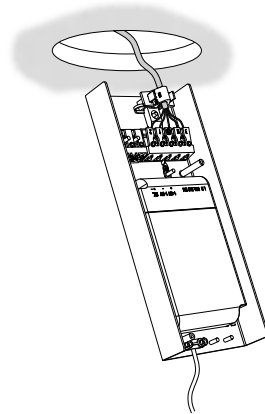

- 1-10V SYSTEM DIMMING
- REGULACIÓN MEDIANTE SISTEMA 1-10 V
- DIMMBAR 1-10V-SYSTEM
- REGOLAZIONE MEDIANTE 1-10V
- VARIATEUR DE PUISSANCE 1-10V

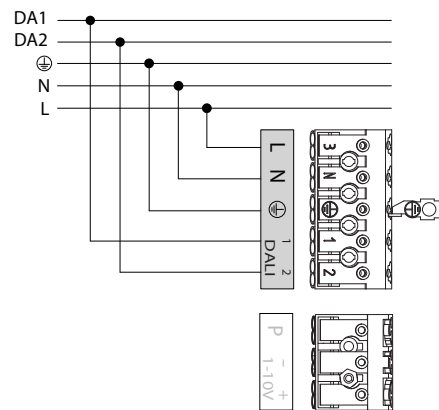

- DALI SYSTEM DIMMING
- REGULACIÓN MEDIANTE SISTEMA DALI
- DIMMER MIT DALI-SYSTEM
- REGOLAZIONE MEDIANTE SISTEMA DALI
- RÉGLAGE À L'AIDE DU SYSTÈME DALI

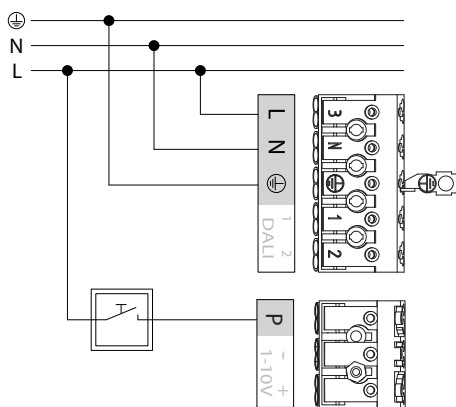

- SWITCH DIMMING
- REGULACIÓN MEDIANTE PULSADOR
- DIMMER MIT TASTEN-REGULIERUNG
- REGOLAZIONE MEDIANTE PULSANTE
- RÉGLAGE DE LUMIÈRE À L'AIDE D'UN COMMUTATEUR

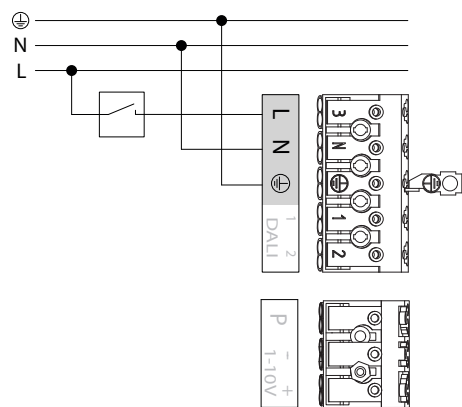

- CASAMBI DIMMER
- REGULACIÓN CASAMBI
- CASAMBI-REGULIERUNG
- REGOLAZIONE CASAMBI
- SMART CASAMBI



Step 5/6
Product Assembly

5.1a

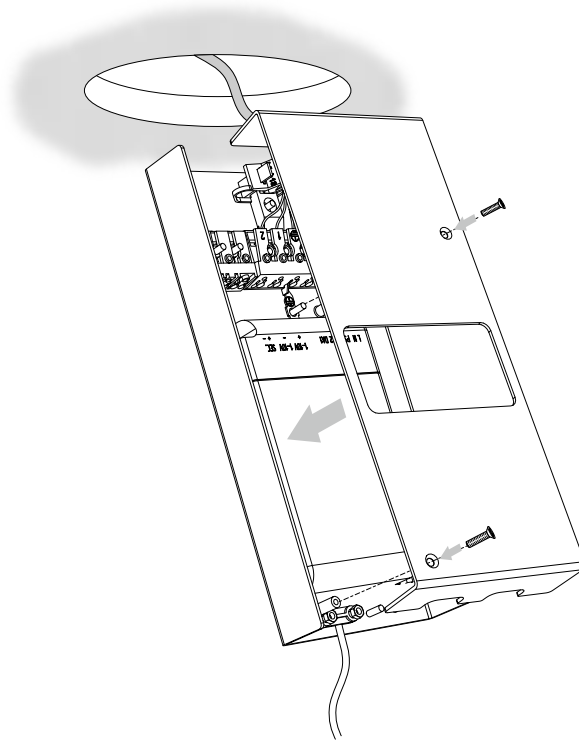

5.2a

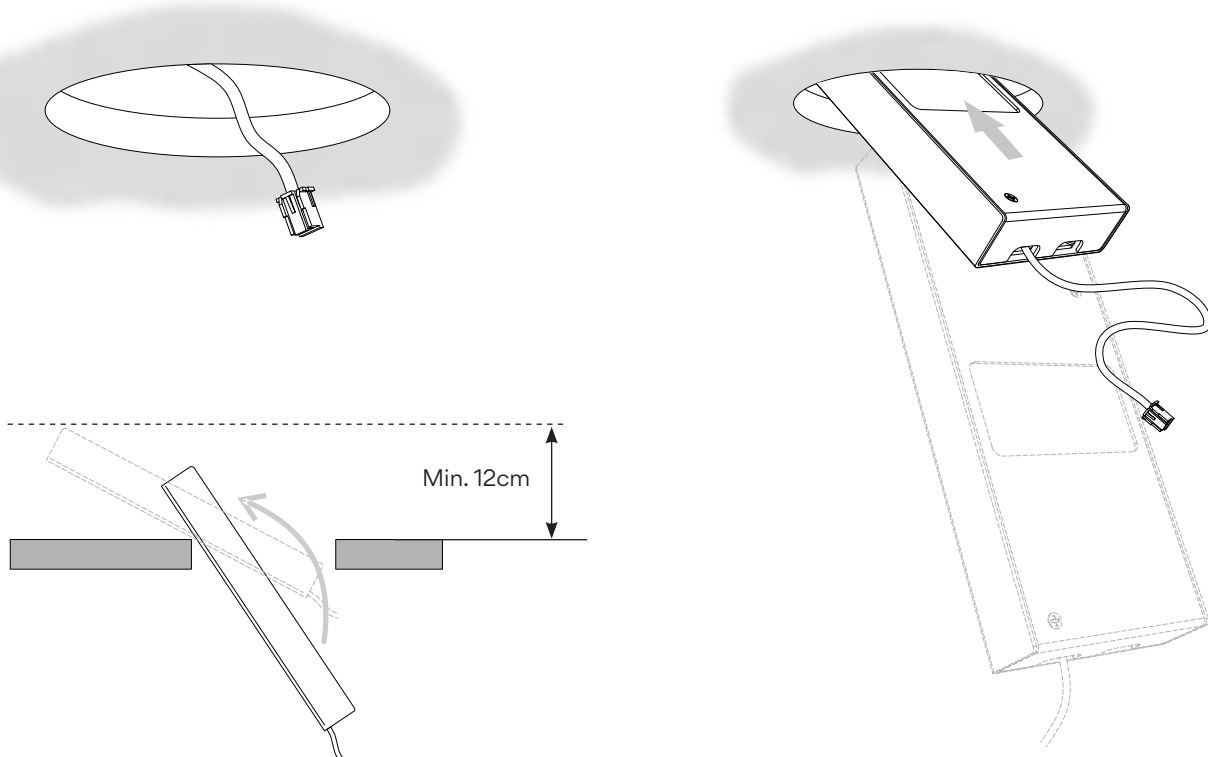



Step 5/6
Product Assembly

5.3a

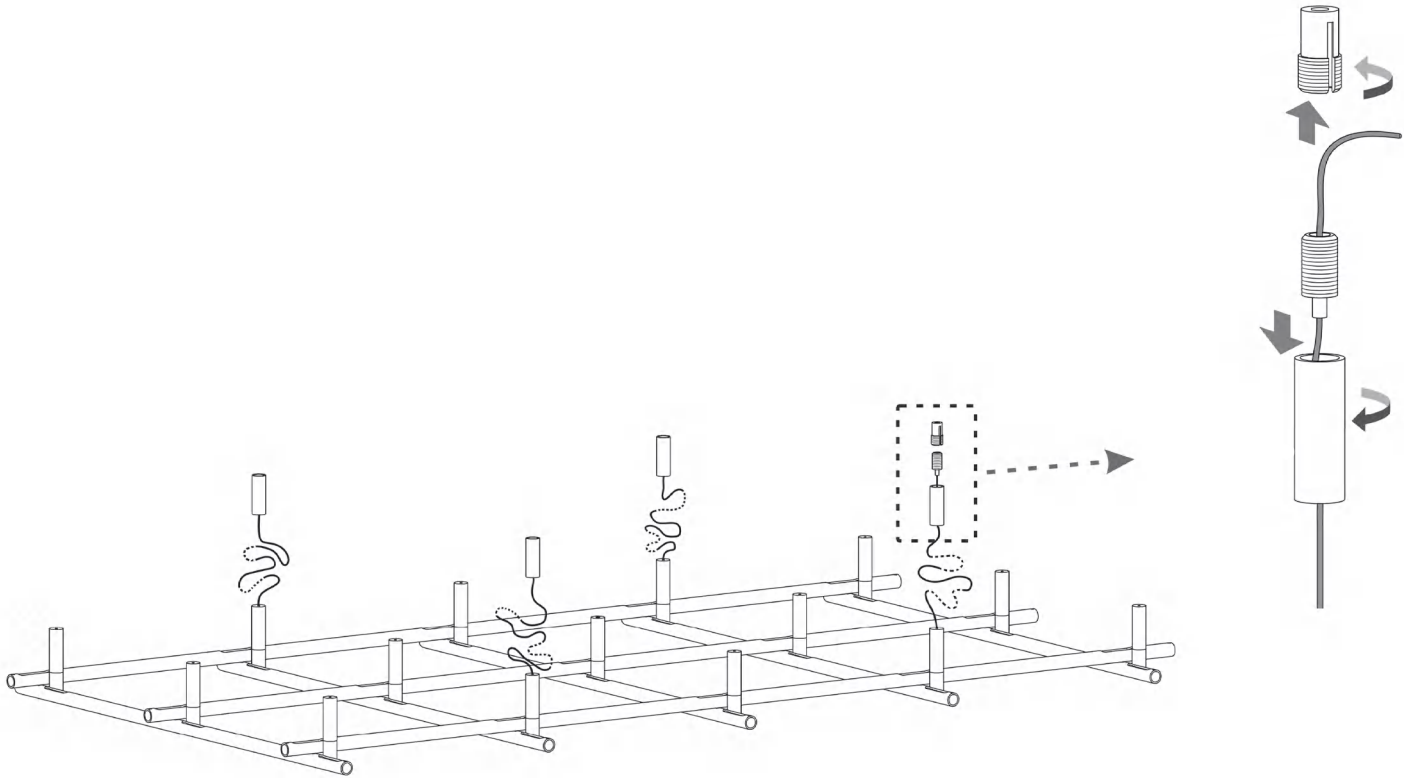

5.4a

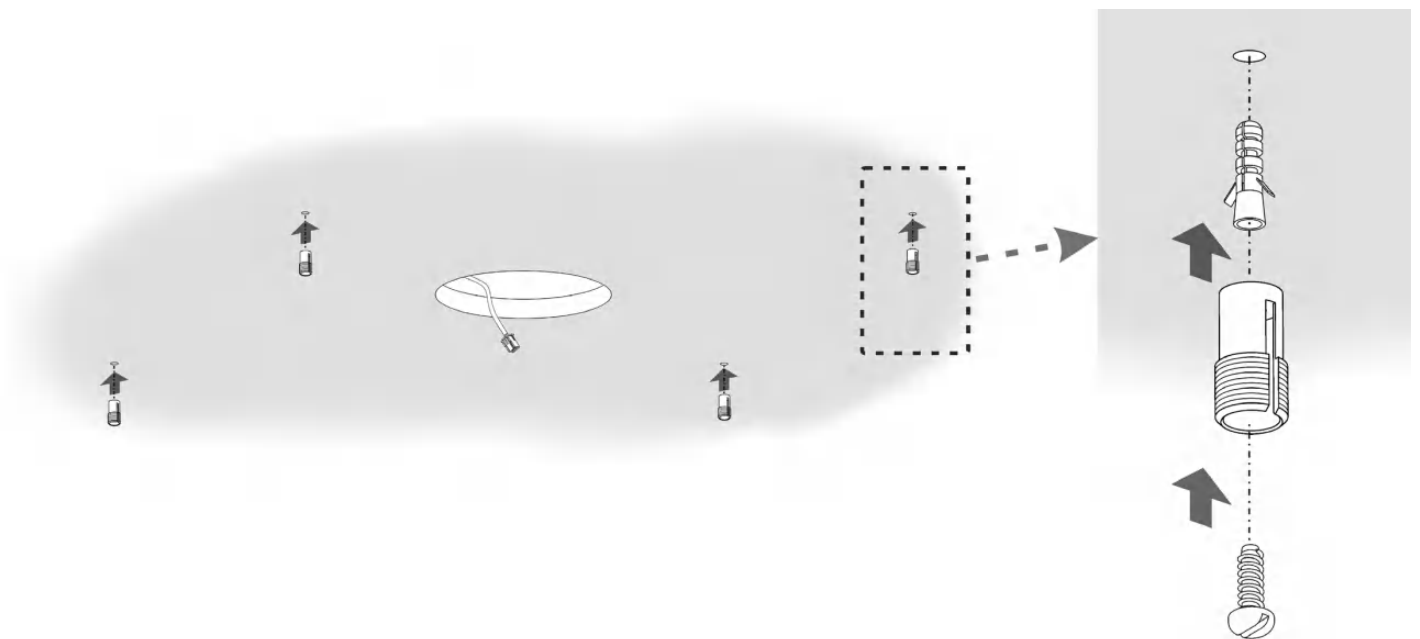



Step 5/6
Product Assembly

5.5a

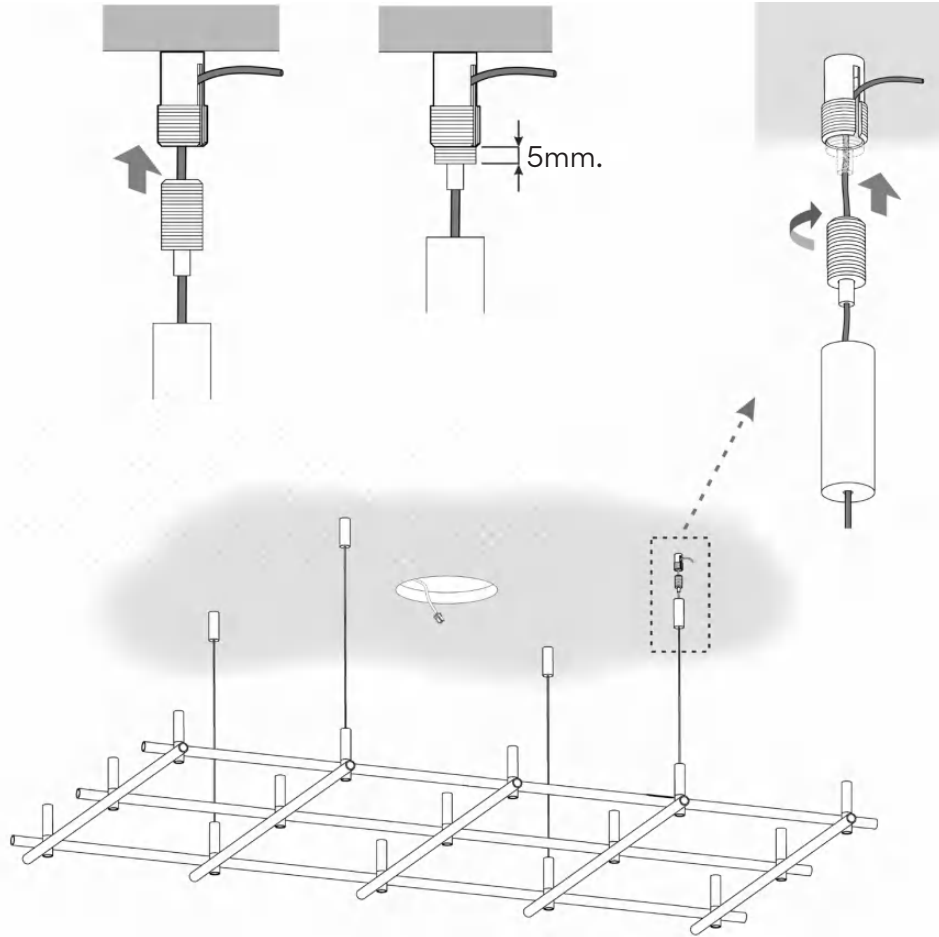

5.6a

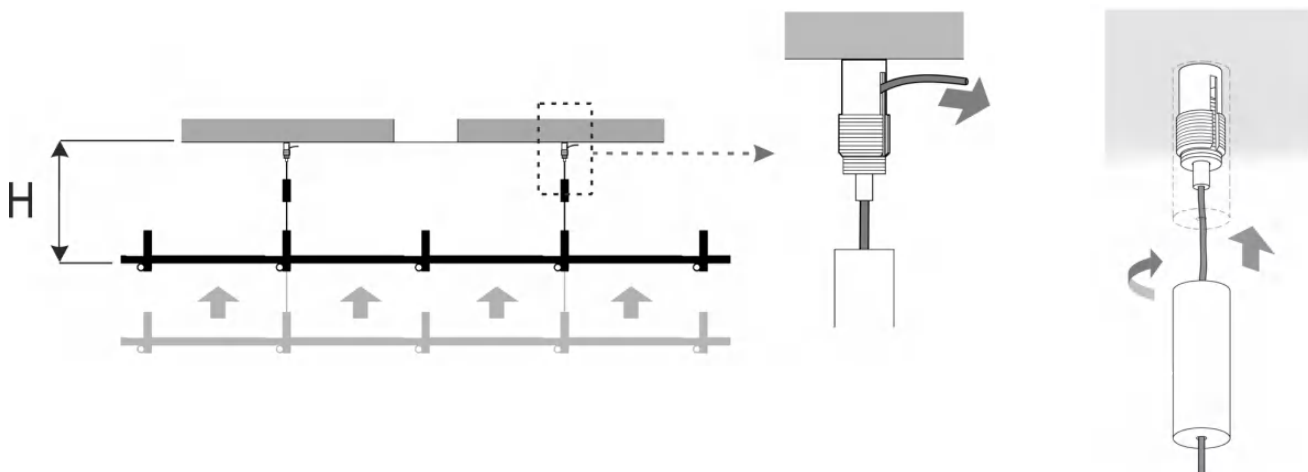



Step 5/6
Product Assembly

5.7a

Ref. 0867

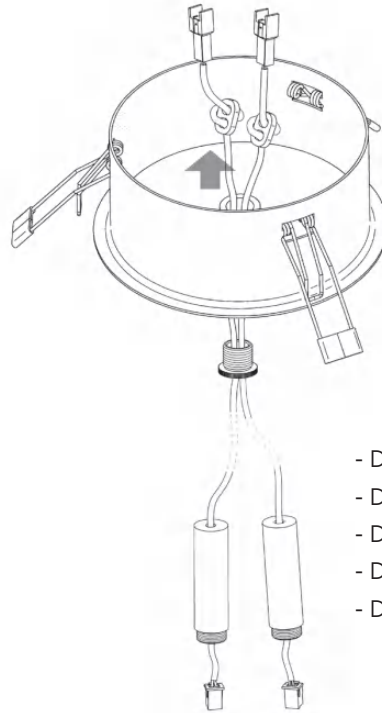
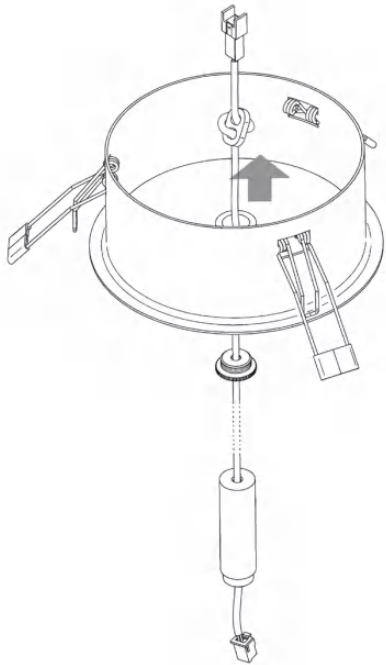

- DOUBLE CABLE
- DOBLE CABLE
- DOPPELTES KABELMIT
- DOPPIO CAVO
- DOUBLE CÂBLE

5.8a

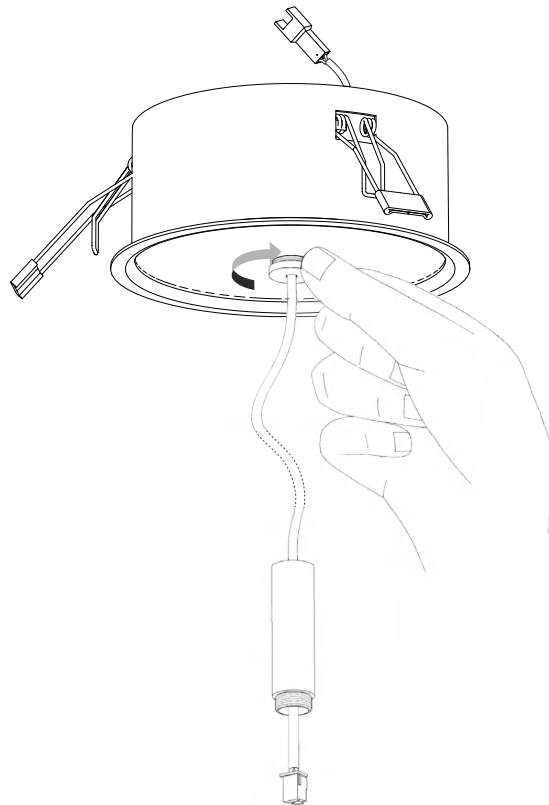



Step 5/6
Product Assembly

5.9a

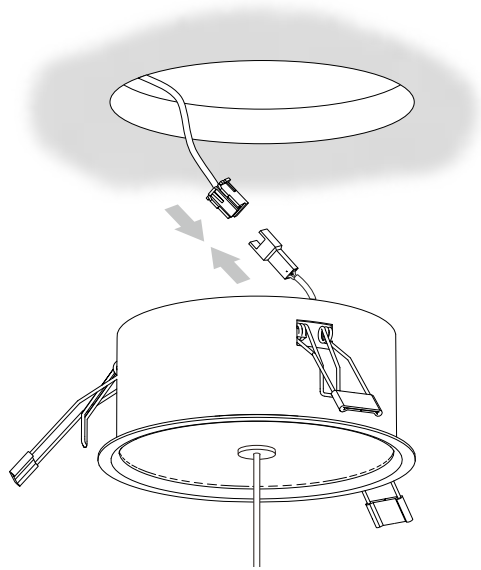

5.10a

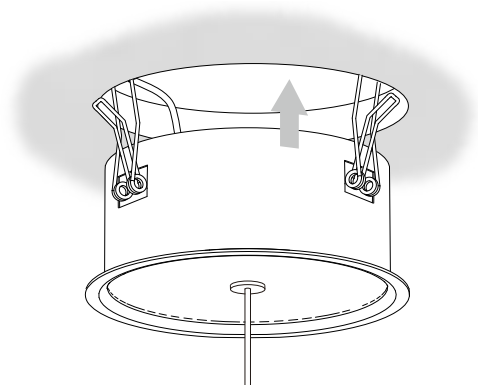
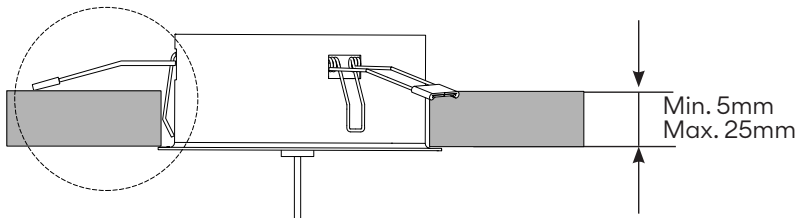

5.11a

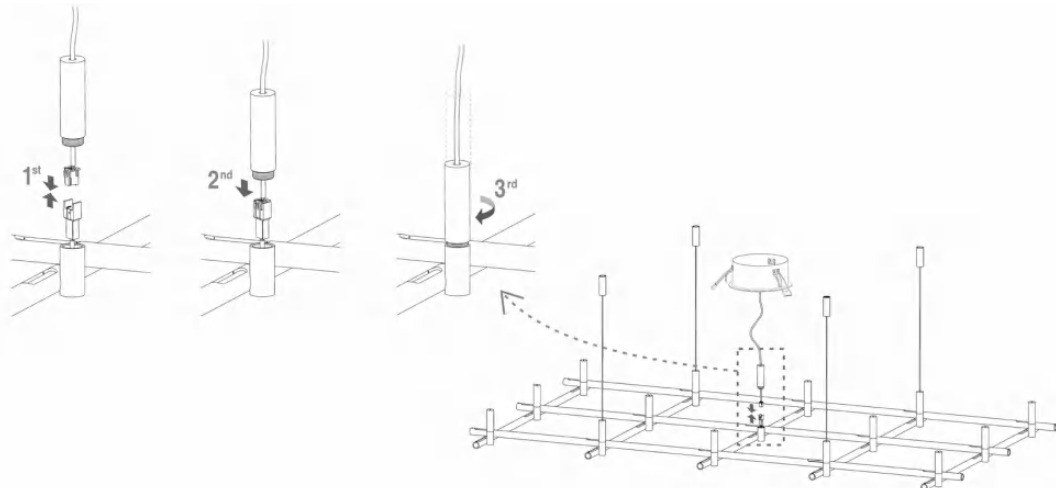



Step 5/6 Product Assembly

5.12a

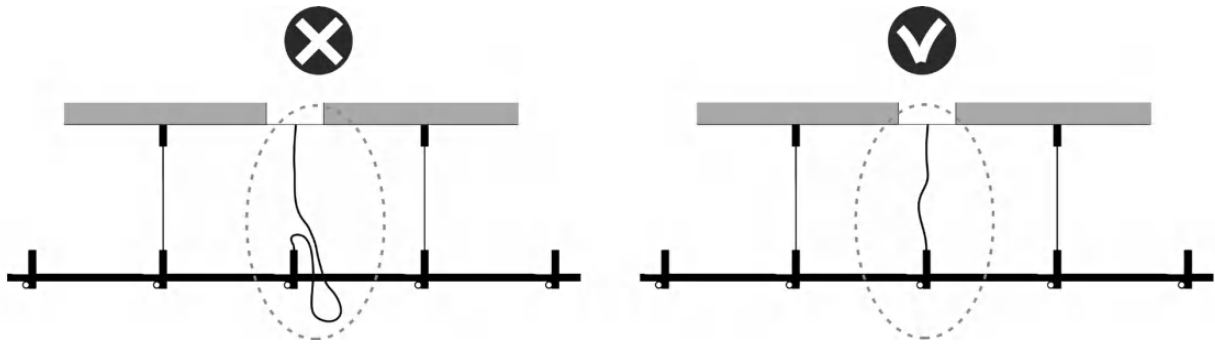

5.13a

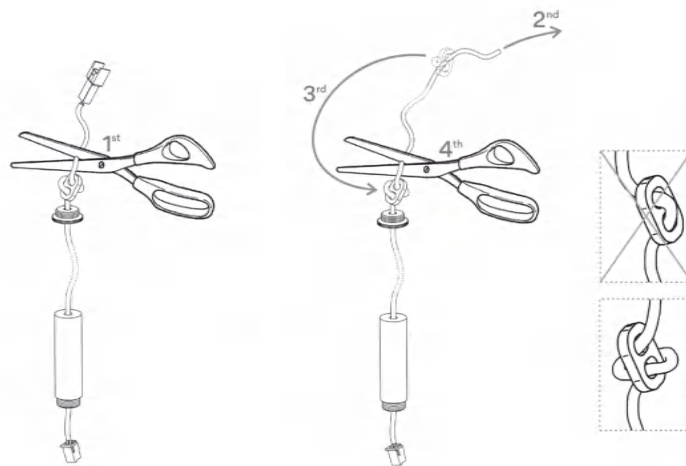

5.14a

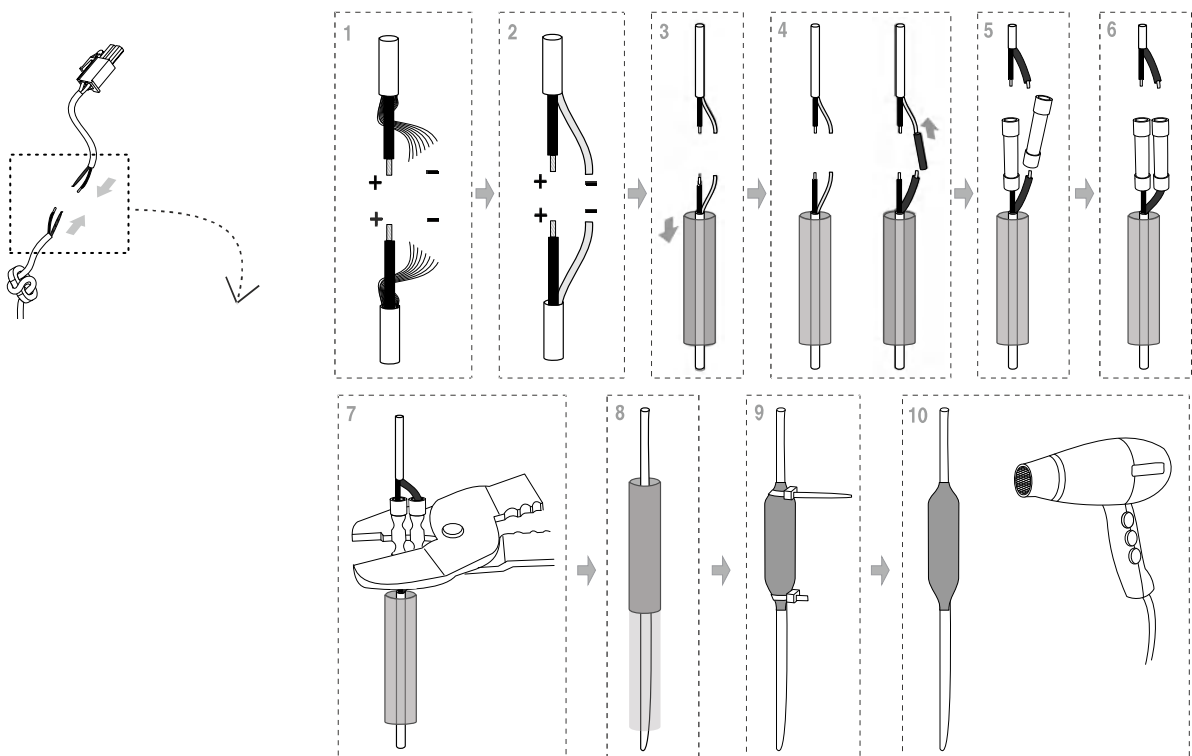



Step 5/6 Product Assembly

5.15a

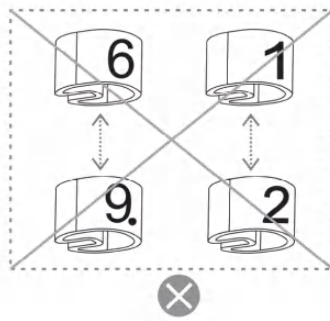
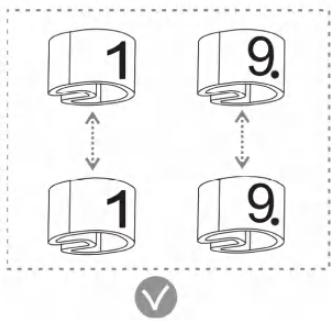
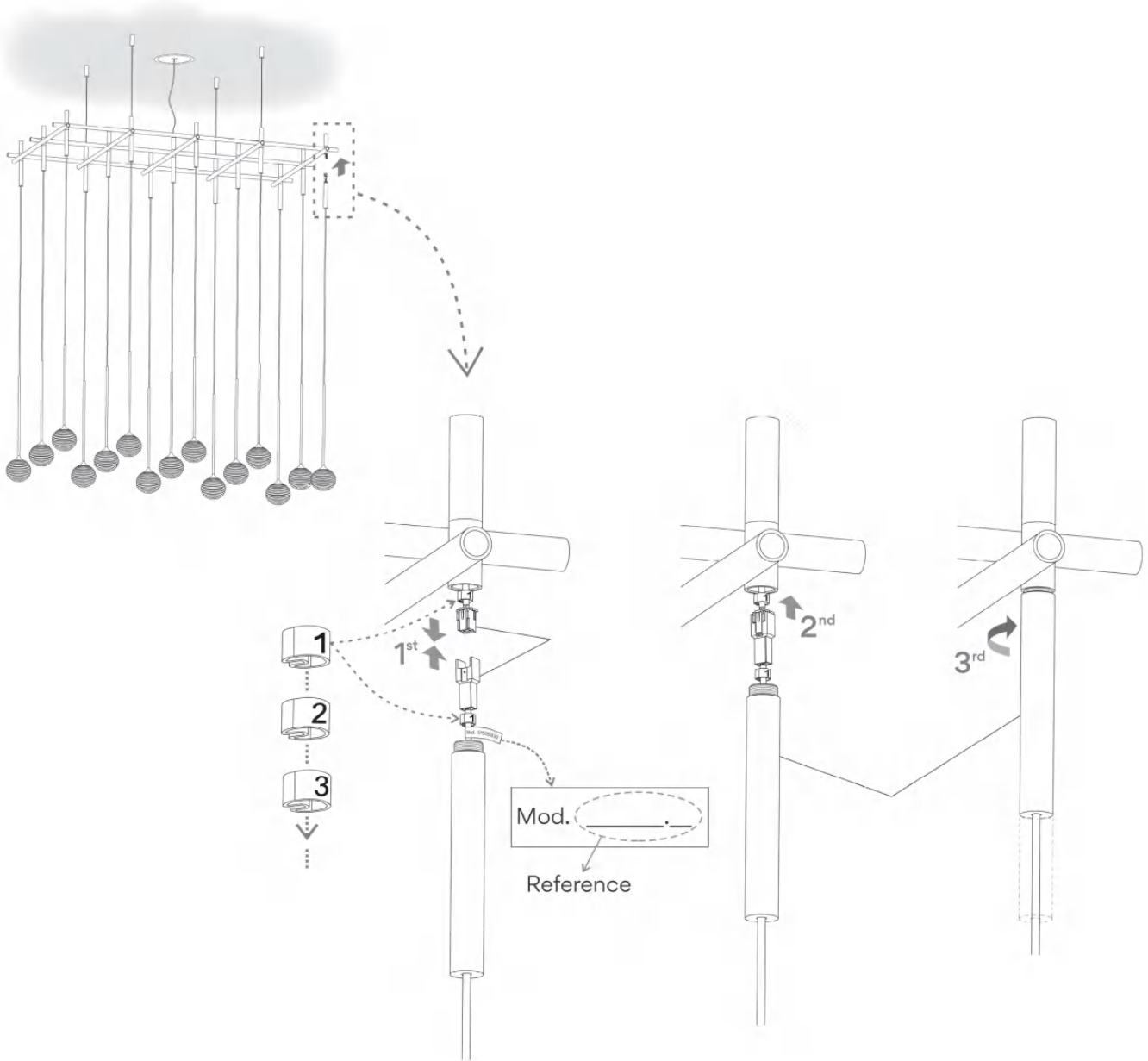



Step 3/6 Installation Preparation

Installation with rods / Instalación con barras / Montage Mit Stangen
Installazione con aste / Installation avec des tiges

OPTION B 3.1b

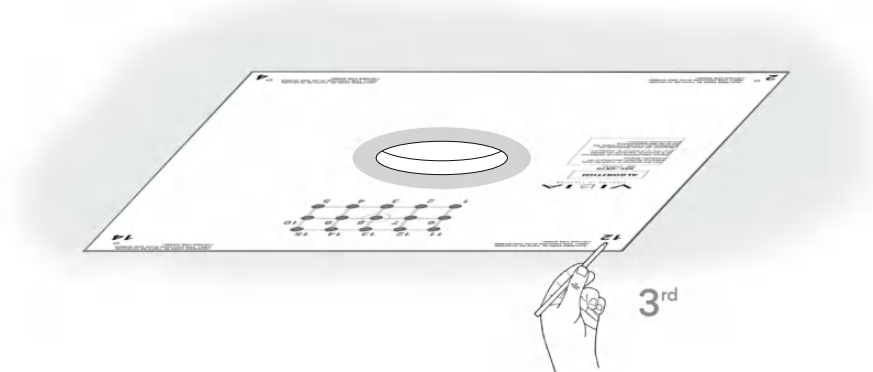
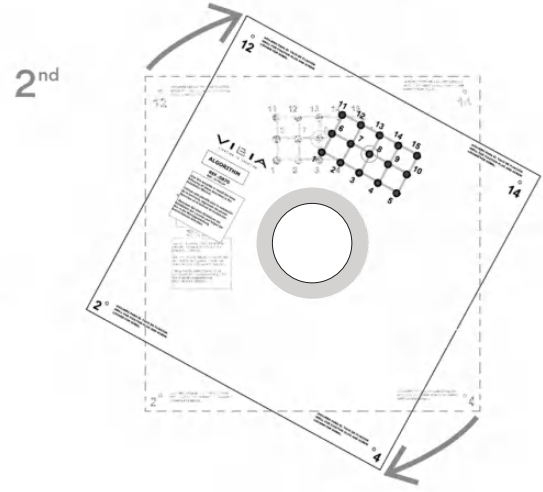
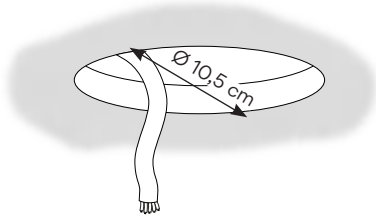
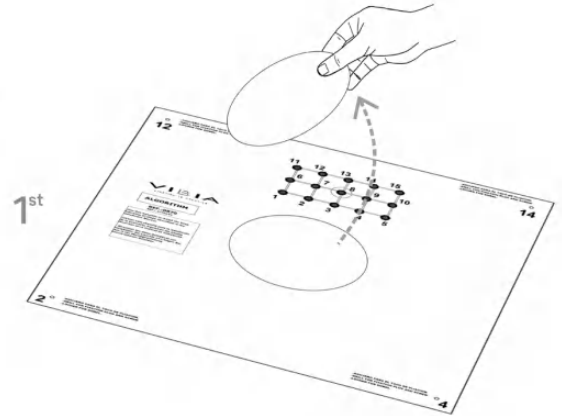
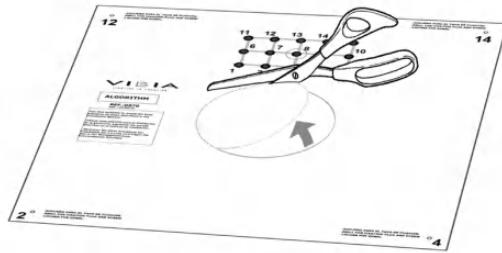



Step 3/6 Installation Preparation

3.2b

Ref. 0827

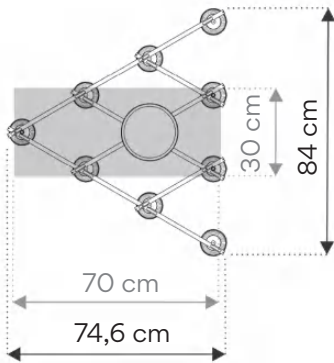

Ref. 0832

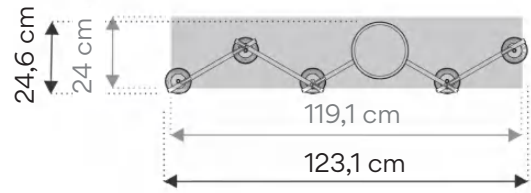

Ref. 0857

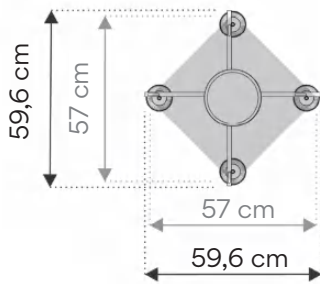

Ref. 0862

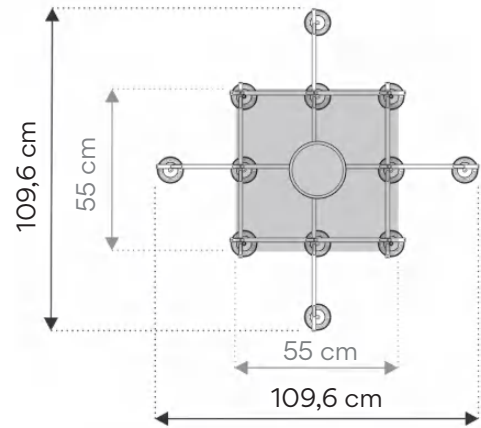

Ref. 0867

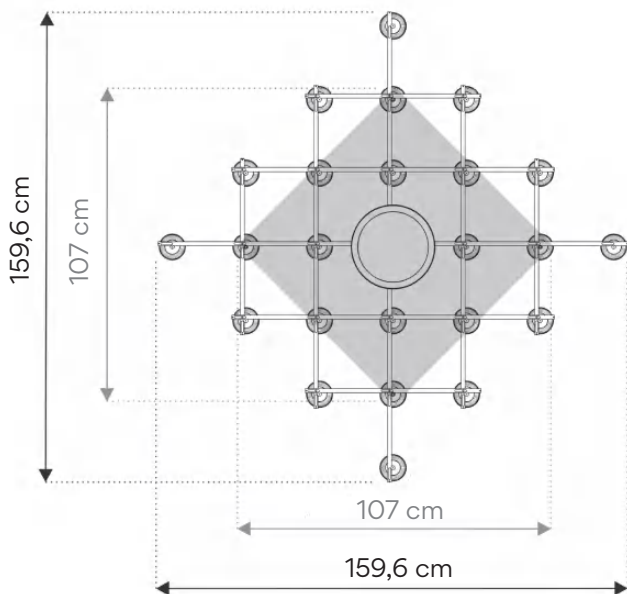

Ref. 0872

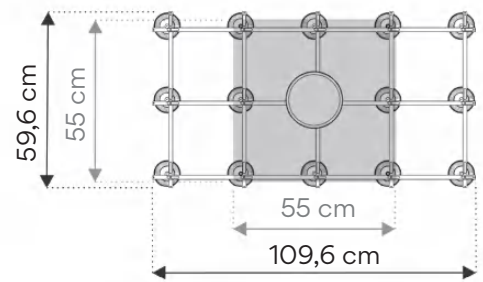

Ref. 0887

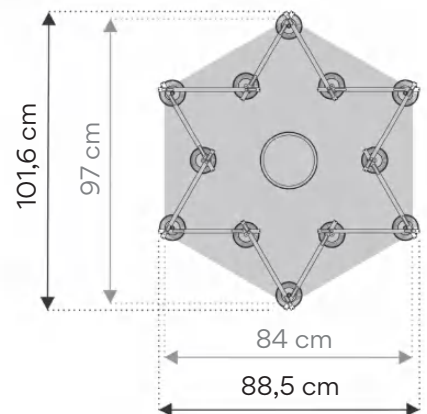



Step 3/6 Installation Preparation

3.3b

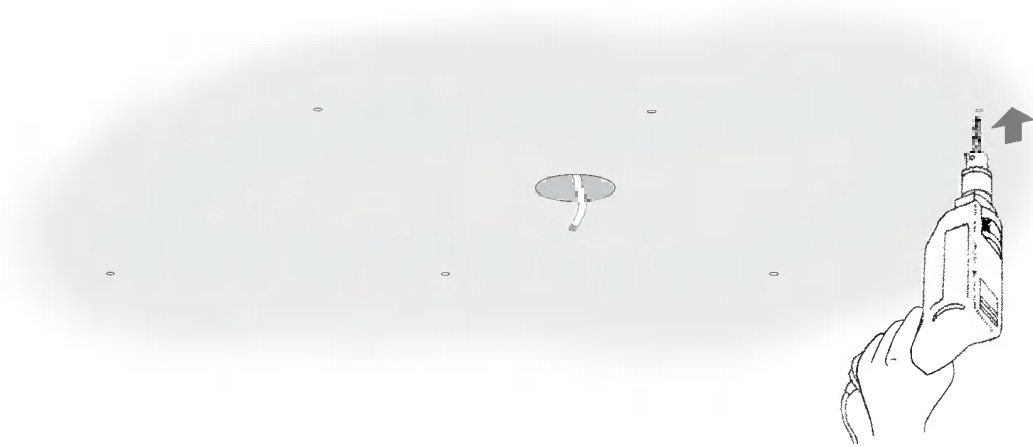

3.4b

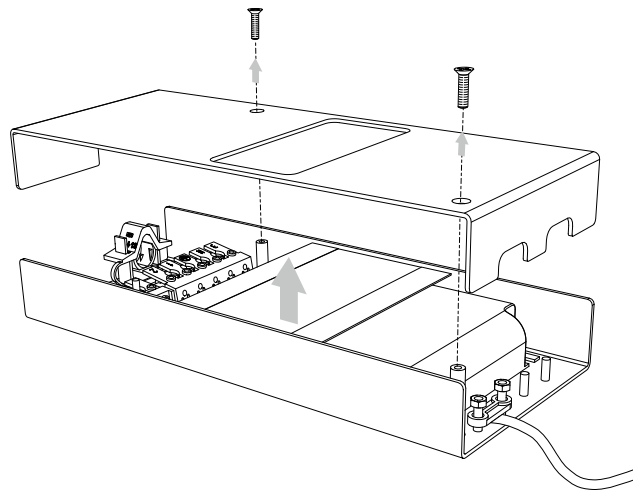

Ref. 0867

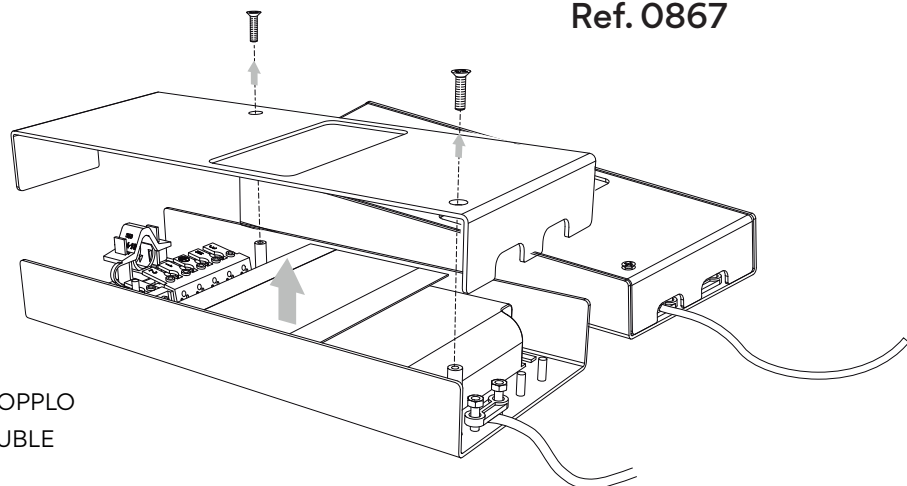

- DOUBLE JUNCTION BOX
- CAJA CONEXIÓN DOBLE
- DOPPEL-ANSCHLUSSBOX
- SCATOLA DI GIUNZIONE DOPPIO
- BOÎTE DE DÉRVATION DOUBLE



Step 4/6 Electrical Connection

4.1b

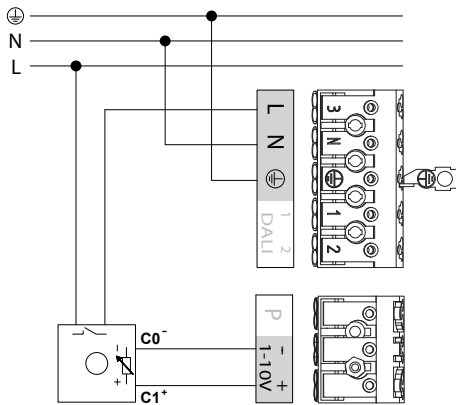
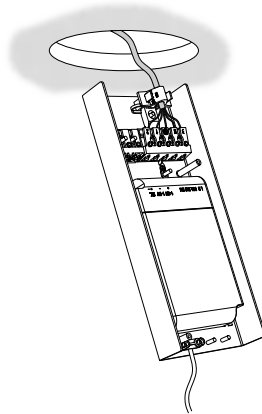

- 1-10V SYSTEM DIMMING
- REGULACIÓN MEDIANTE SISTEMA 1-10 V
- DIMMBAR 1-10V-SYSTEM
- REGOLAZIONE MEDIANTE 1-10V
- VARIATEUR DE PUISSANCE 1-10V

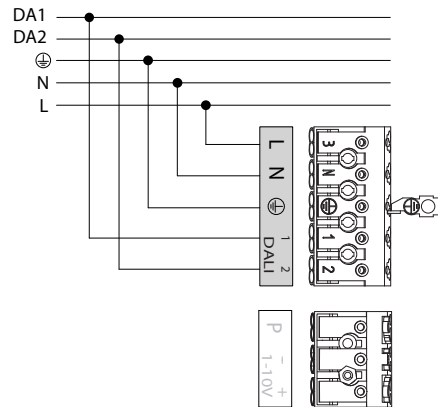

- DALI SYSTEM DIMMING
- REGULACIÓN MEDIANTE SISTEMA DALI
- DIMMER MIT DALI-SYSTEM
- REGOLAZIONE MEDIANTE SISTEMA DALI
- RÉGLAGE À L'AIDE DU SYSTÈME DALI

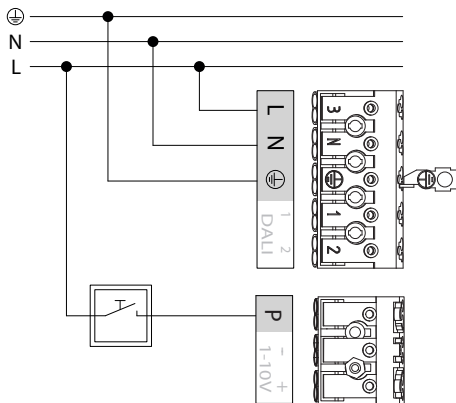

- SWITCH DIMMING
- REGULACIÓN MEDIANTE PULSADOR
- DIMMER MIT TASTEN-REGULIERUNG
- REGOLAZIONE MEDIANTE PULSANTE
- RÉGLAGE DE LUMIÈRE À L'AIDE D'UN COMMUTATEUR

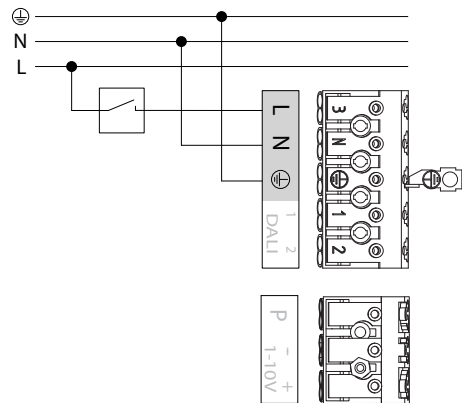

- CASAMBI DIMMER
- REGULACIÓN CASAMBI
- CASAMBI-REGULIERUNG
- REGOLAZIONE CASAMBI
- SMART CASAMBI



Step 5/6
Product Assembly

5.1b

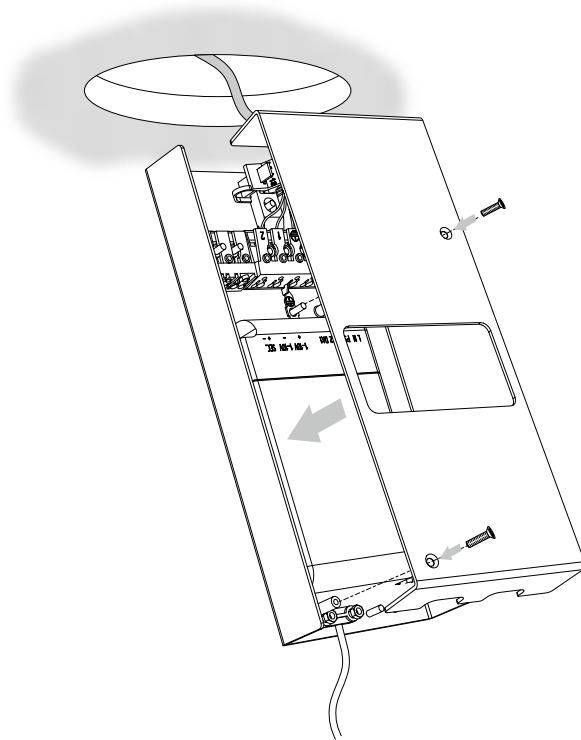

5.2b

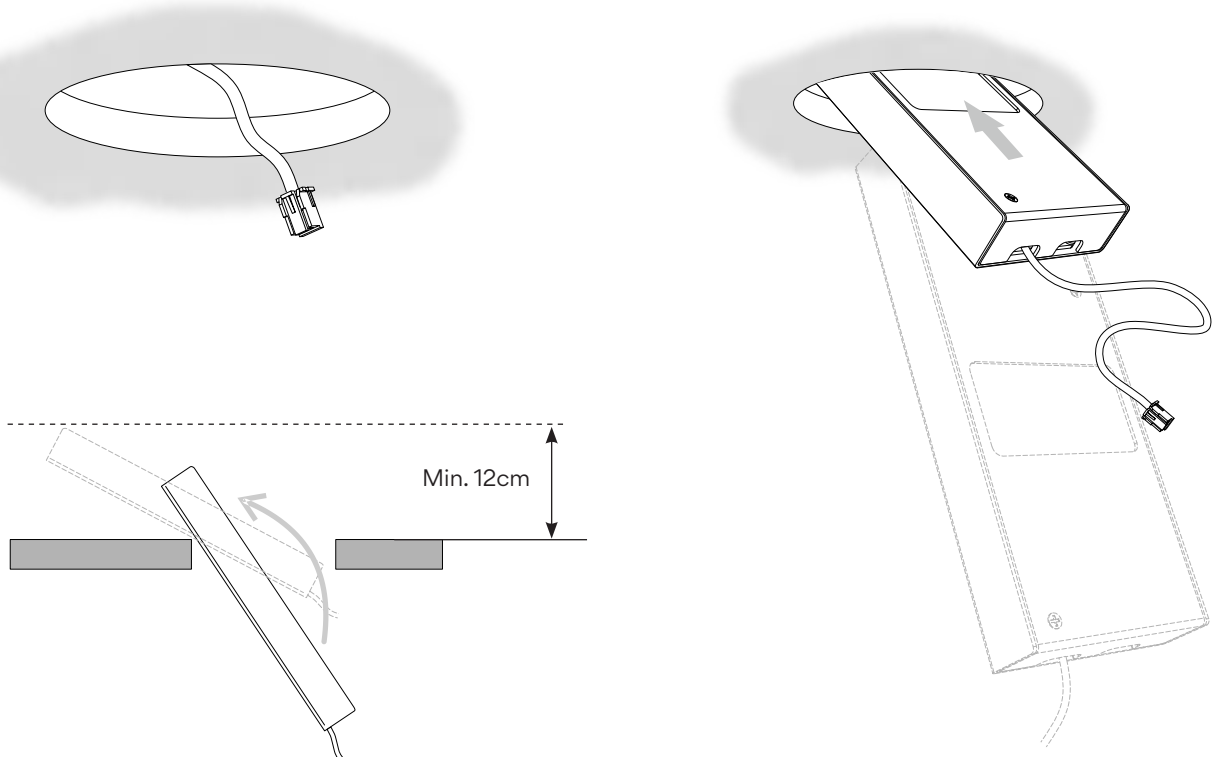



Step 5/6
Product Assembly

5.3b

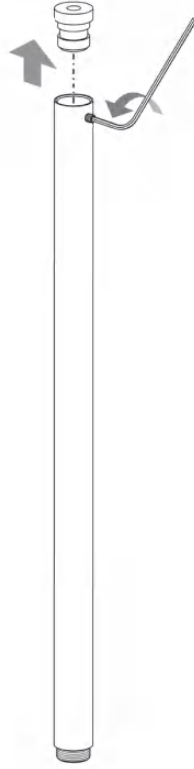

5.4b

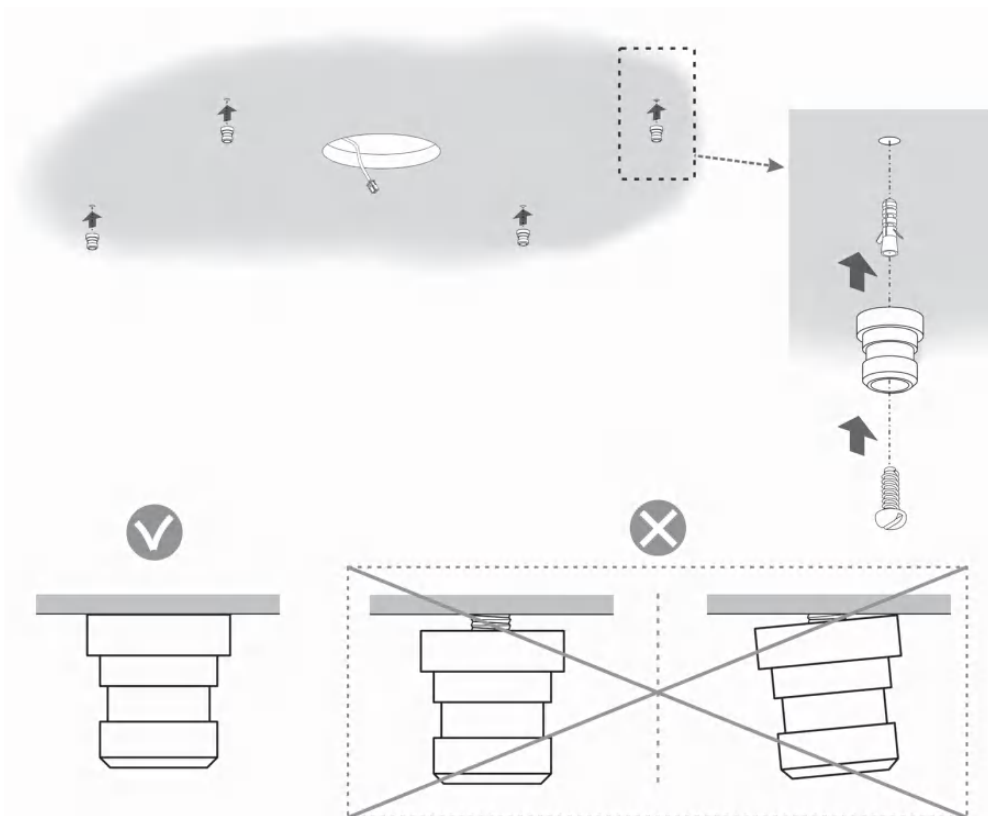



Step 5/6
Product Assembly

5.5b

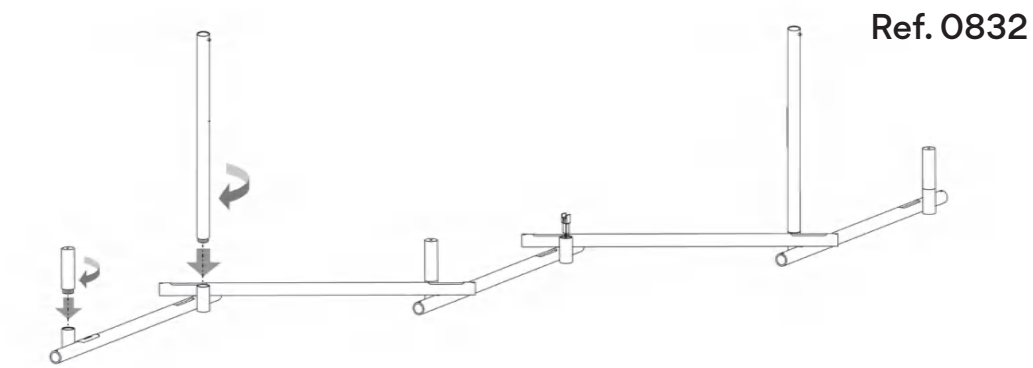
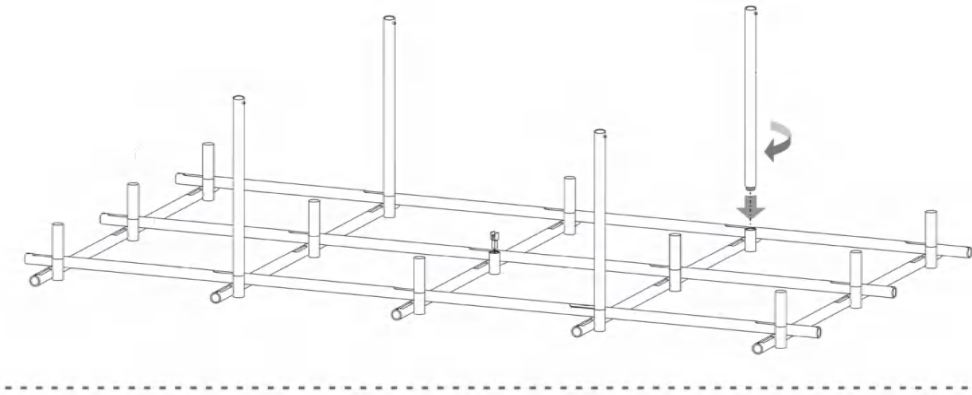

5.6b

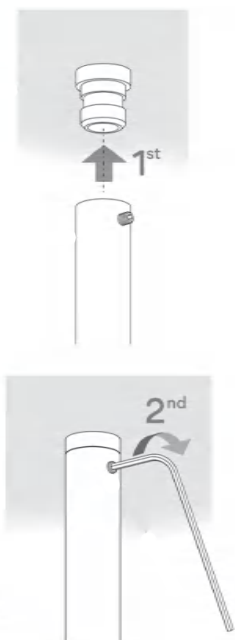
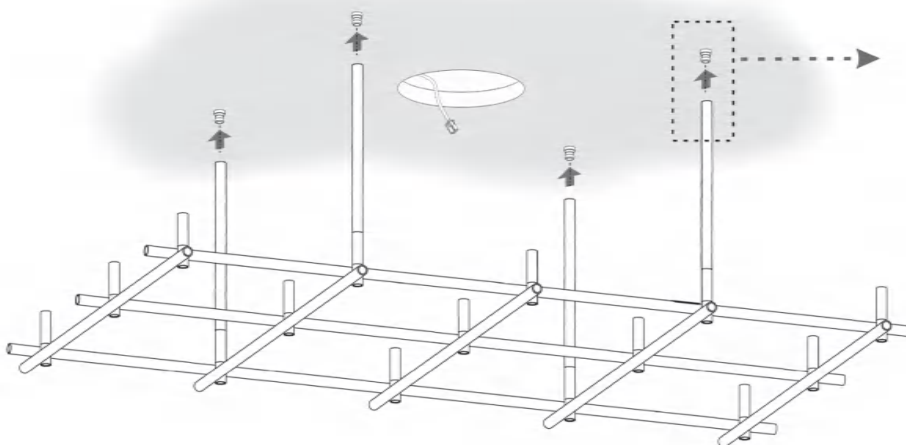
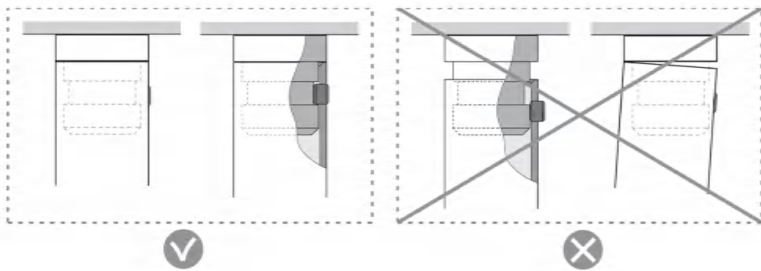



Step 5/6
Product Assembly

5.7b

Ref. 0867

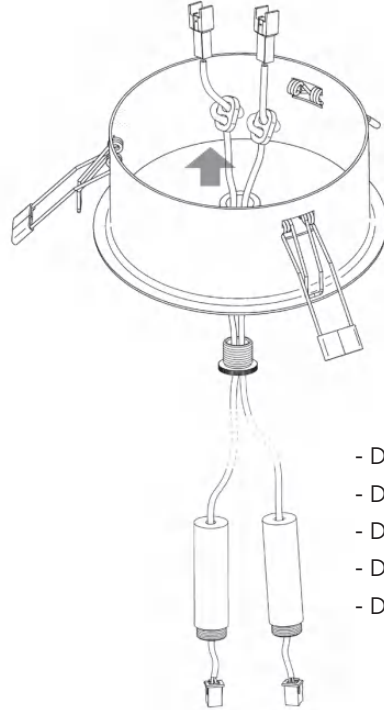
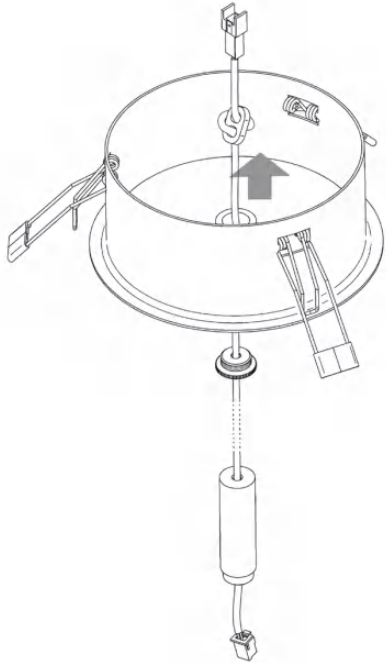

- DOUBLE CABLE
- DOBLE CABLE
- DOPPELTES KABELMIT
- DOPPIO CAVO
- DOUBLE CÂBLE

5.8b

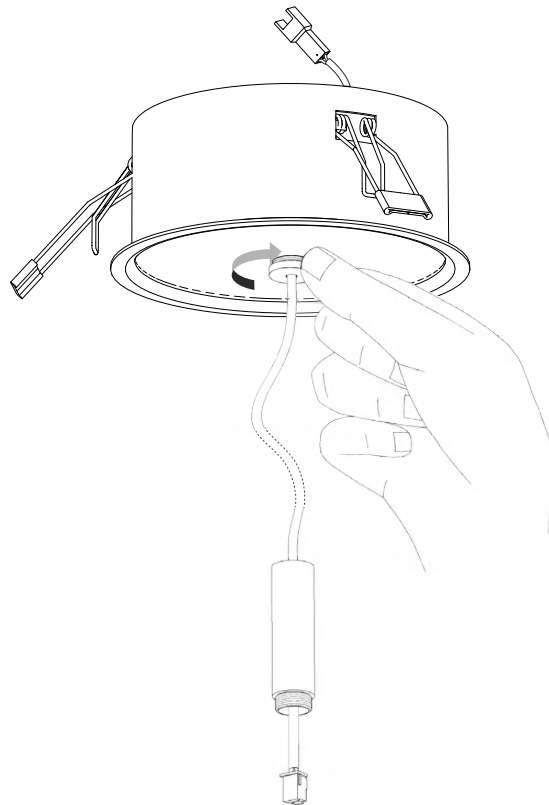



Step 5/6
Product Assembly

5.9b

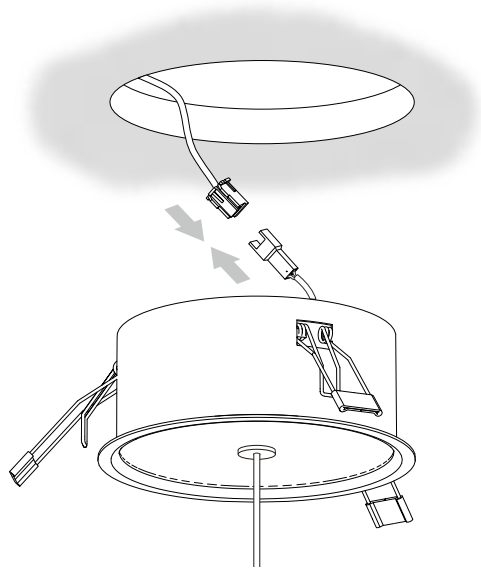

5.10b

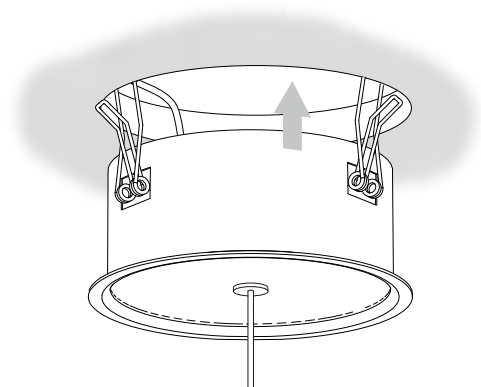
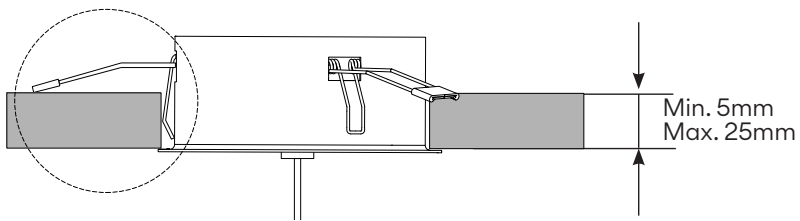

5.11b

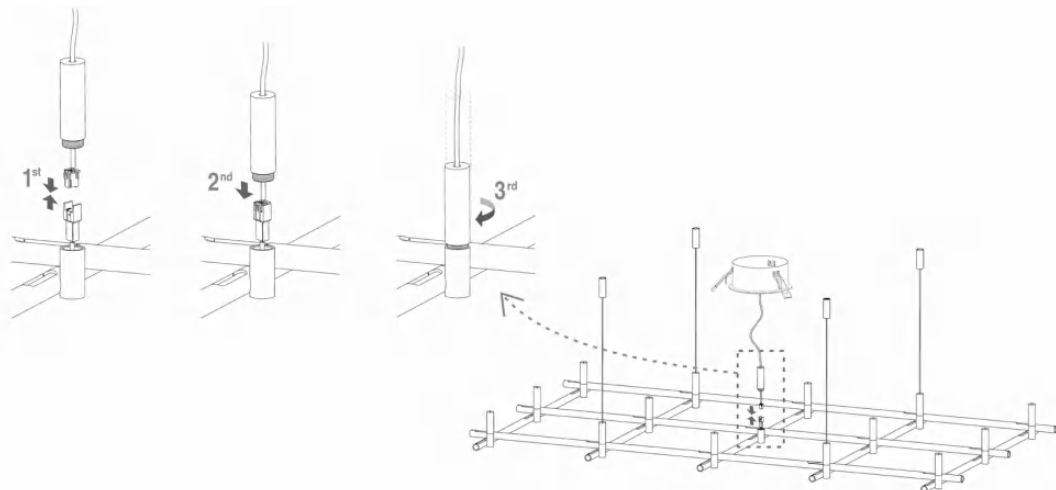



Step 5/6 Product Assembly

5.12b

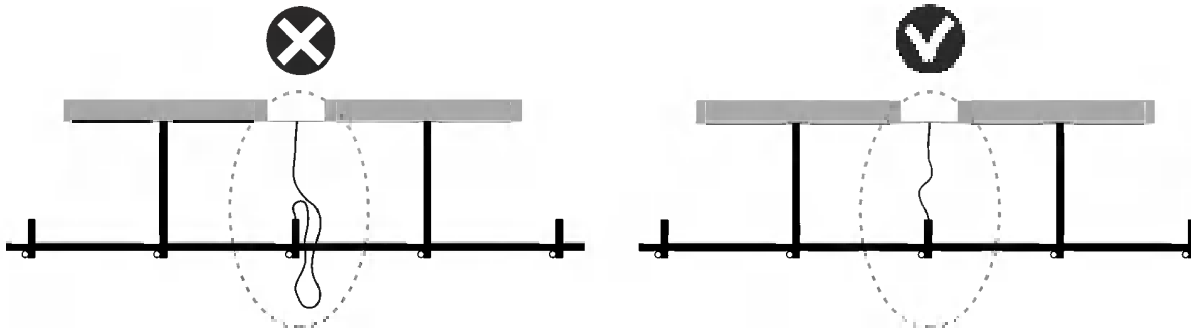

5.13b

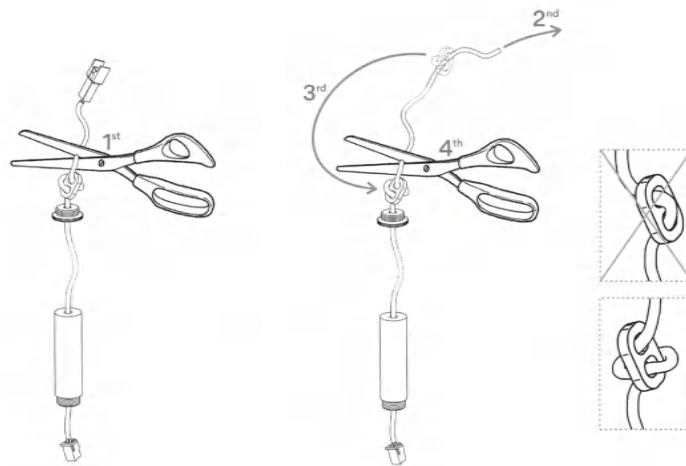

5.14b

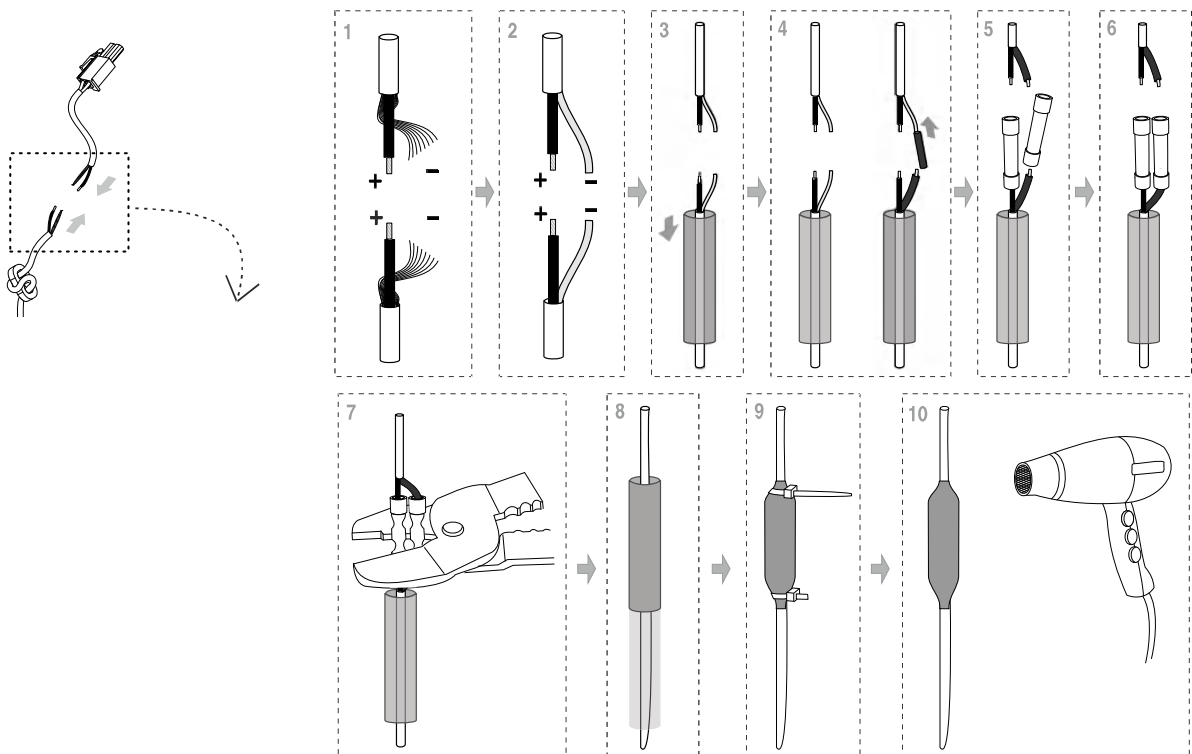



Step 5/6
Product Assembly

5.15b

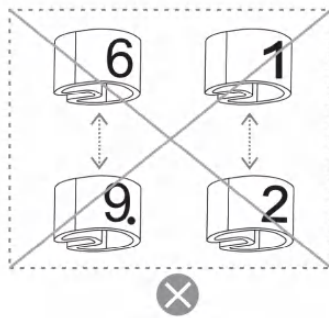
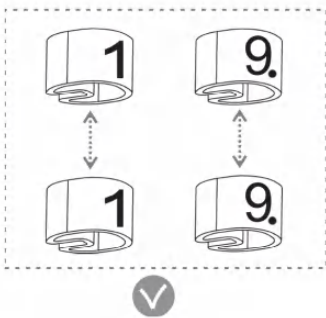
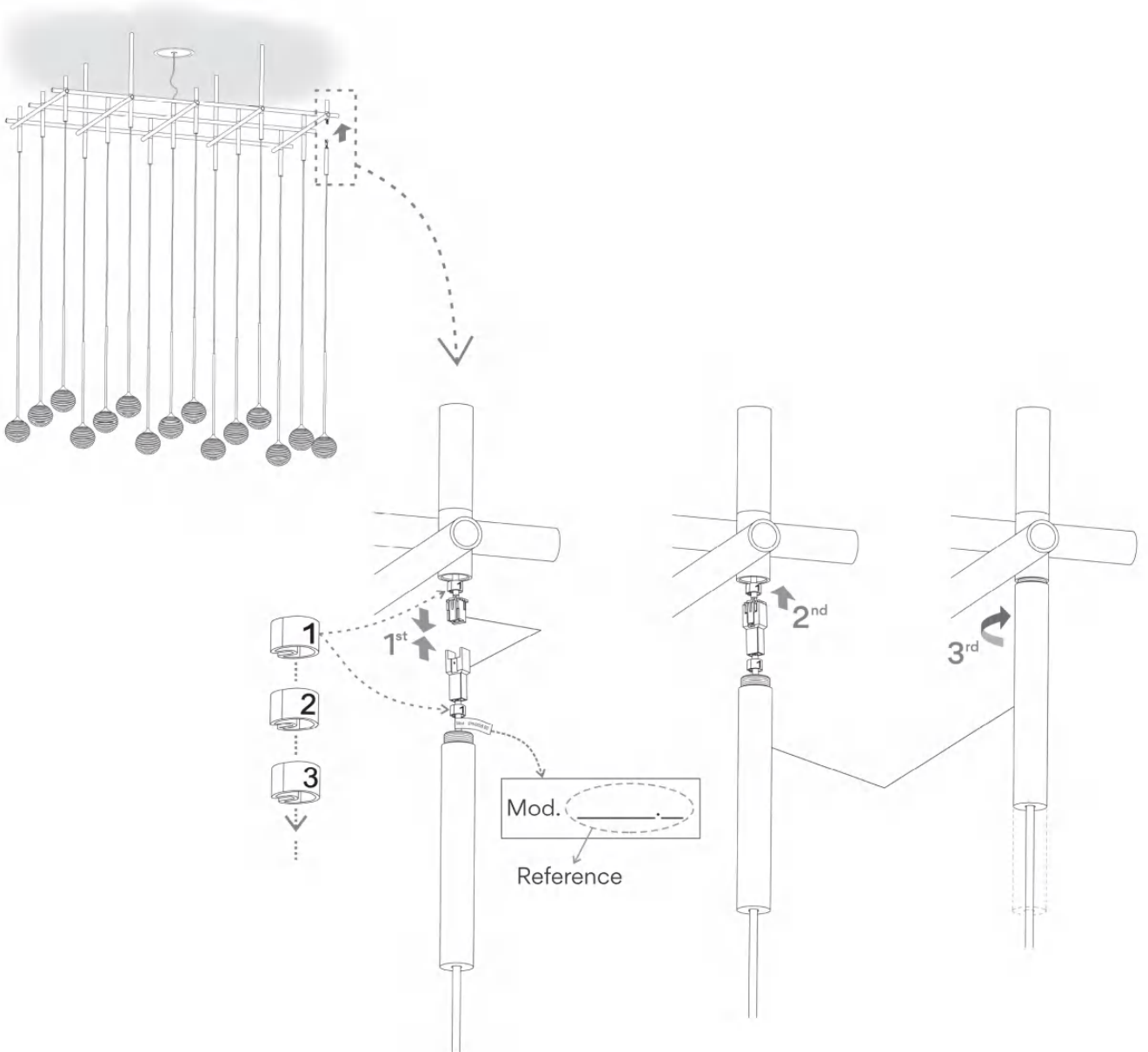



Step 6/6

Adjustments & maintenance

6.1ab

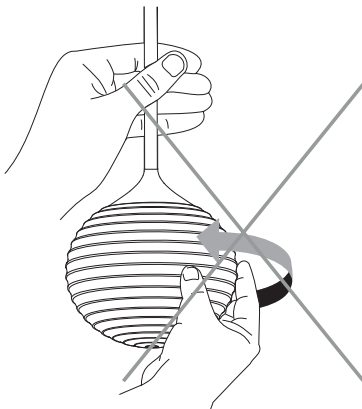
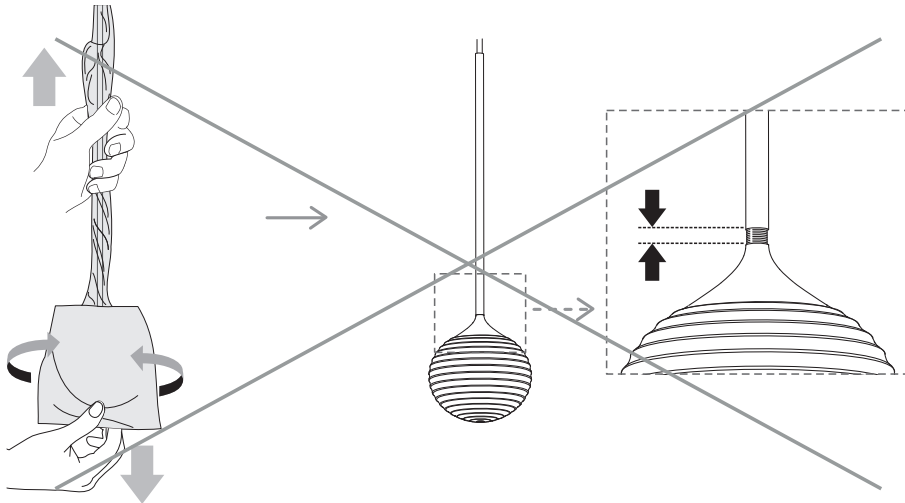
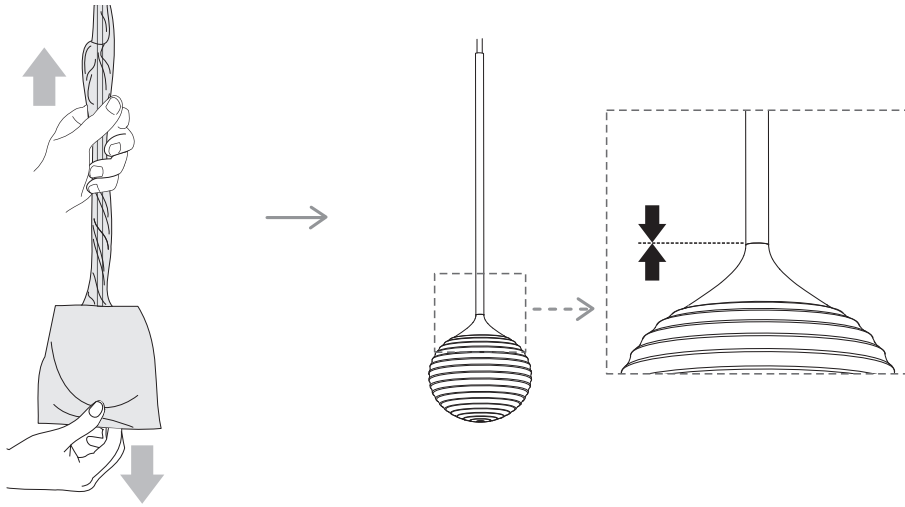

- Use the gloves provided
- Usar guantes suministrados
- Nutzen Sie die mitgelieferten Handschuhe
- Indossare i guanti forniti
- Utilisez les gants fournis



Step 6/6
Adjustments & maintenance

6.2ab

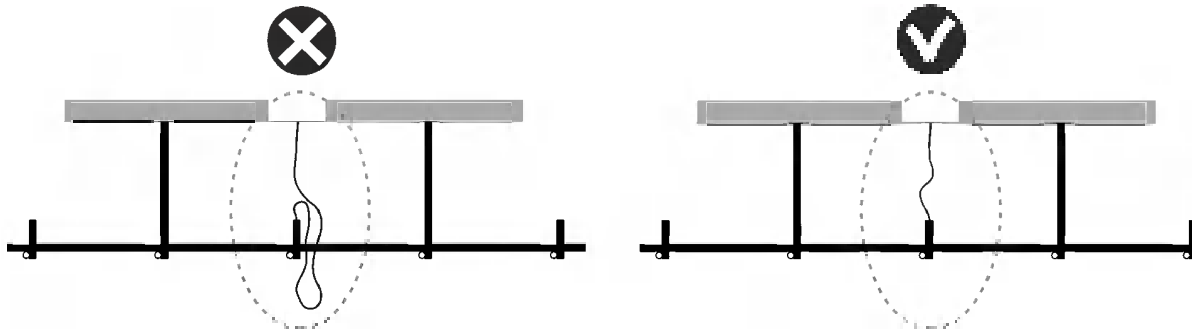

6.3ab

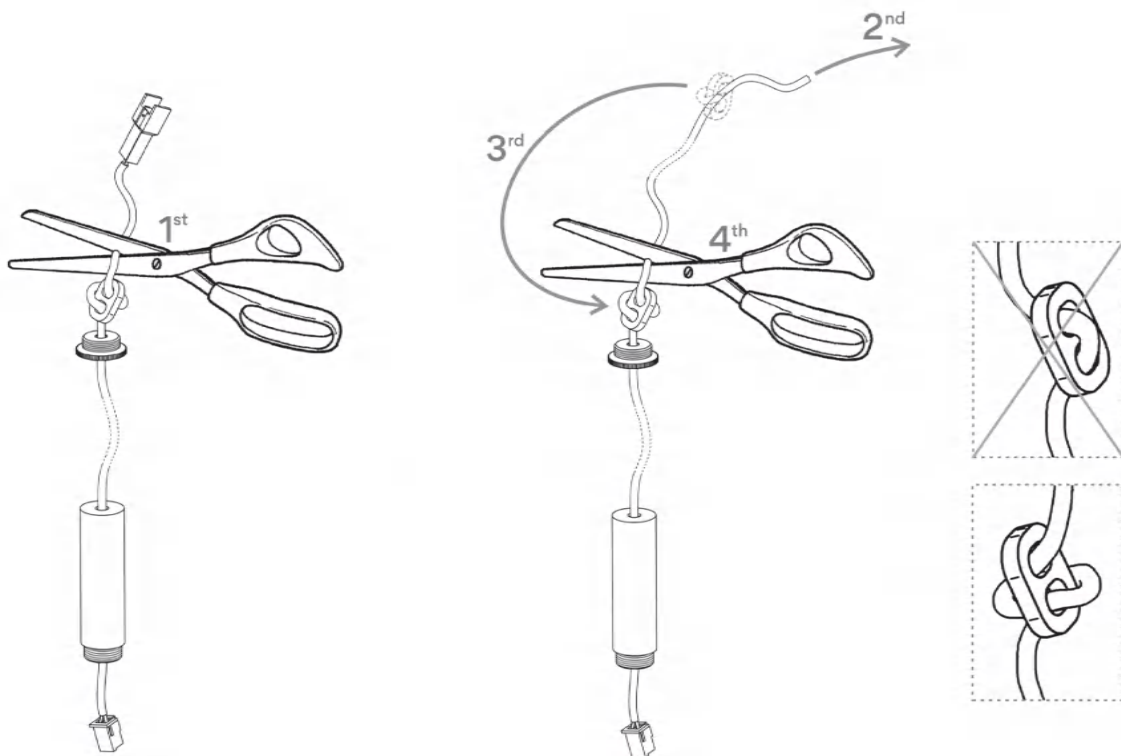



Step 6/6 Adjustments & maintenance

6.5ab

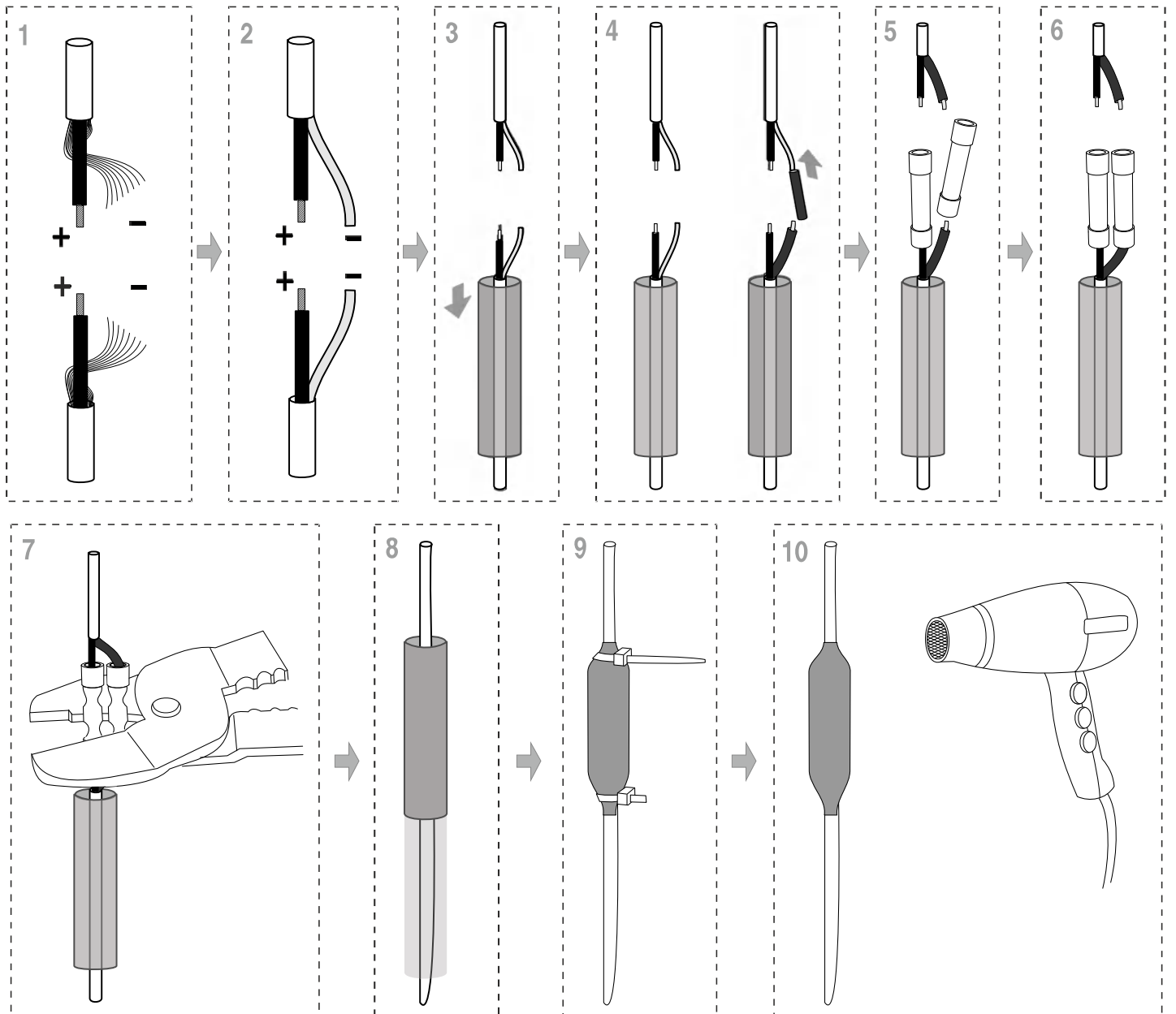
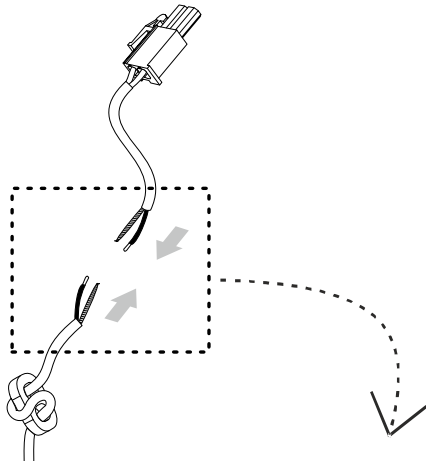



Step 6/6

Adjustments & maintenance

MICROFIBER
CLOTH

PAÑO DE
MICROFIBRA

MIKROFASER-
TUCH

PANNO IN
MICROFIBRA

CHIFFON EN
MICROFIBRE



EN

ATTENTION:

A microfiber cloth is supplied to clean the lamp's surfaces.

Do not damp the cloth nor use it with detergents or abrasive products.

ES

ATENCIÓN:

Se suministra un paño de microfibra para la limpieza de las superficies de la luminaria.

No humedecer el paño, ni utilizarlo con detergentes o productos abrasivos.

D

ACHTUNG:

Zur Reinigung der Leuchtenoberfläche wird ein Mikrofasertuch mitgeliefert.

Befeuchten Sie das Tuch nicht und nutzen Sie keine Reinigungs- oder Scheuermittel.

IT

ATTENZIONE:

È compreso un panno in microfibra per la pulizia delle superfici della lampada.

Non inumidire il panno né utilizzarlo con detergenti o prodotti abrasivi.

FR

ATTENTION:

Un chiffon en microfibre est fourni pour le nettoyage des surfaces du luminair.

Ne mouillez pas le chiffon et n'utilisez pas de détergent ou de produit abrasif.

Maintenance

Use a slightly-wet cotton cloth for cleaning.

In case of malfunction or damage, please contact the retailer who sold the lamp.

Mantenimiento

Para limpiar la luminaria, usar un paño de algodón ligeramente humedecido en agua.

En caso de avería o incidente con la luminaria, contactar directamente con el establecimiento en que se adquirió.

Instandhaltung

Zur Reinigung der Leuchte nutzen Sie einen leicht angefeuchteten Baumwoll-Lappen.

Im Falle des Ausfalls oder einer Fehlfunktion der Leuchte setzen Sie sich direkt mit dem Unternehmen in Verbindung bei dem Sie die Leuchte bezogen haben.

Manutenzione

Per la pulizia della lampada, usare un panno di cotone leggermente inumidito con acqua.

In caso di guasto o incidente con la lampada, rivolgersi direttamente al rivenditore da cui è stata acquistata.

Entretien

Pour nettoyer le luminaire, utilisez un chiffon en coton légèrement humidifié d'eau.

En cas d'incident ou de défaillance du luminaire, contactez directement l'établissement où vous l'avez acheté.

Vibia Lighting, S.L.U.

Spain & Portugal T. +34 934 796 970

International T. +34 934 796 971

customer.service@vibia.com

www.vibia.com

VIBIA