

FLOS

 F1366035 Red

Smithfield Ceiling Pro

Designed by Jasper Morrison, 2009



45W - 2791lm - 2700K - CRI> 95

Ceiling-mounted lamp providing direct light. Aluminium body. Available in gloss black, white, matt black, red, green or MUD. Injection-moulded opalescent methacrylate diffuser. Steel wall and ceiling attachment.

Are you a professional and your project needs consulting and support?

[BOOK AN APPOINTMENT](#)

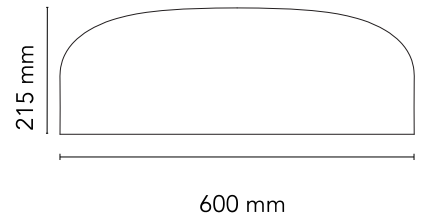

Main specifications

EAN	8059607014912
Mounting	Ceiling
Environments	Indoor dry location
Light Source Type	LED
LED type	LED Module
Power (W)	45
System power (W)	45
System flux (lm)	2791

Physical

Colour	Red
Net weight (kg)	5.8
Package volume (m3)	0.16
IP internal	20

Download

[Mounting instructions](#)  PDF

[Spare Parts](#)  PDF

Photometric Files

[LDT / IES](#)  LDT

Technical Drawings

[2D](#)  ZIP

[3D](#)  ZIP

[Bim](#)  ZIP



Schematic light drawing

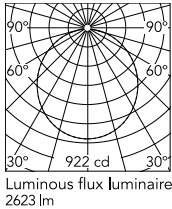

Photometric

Lighting type	Direct
Light distribution	Roto symmetric
CCT (K)	2700
CRI>	95

Electrical

Insulation class	I
Frequency (Hz)	50/60
Main voltage (Vac)	200-240
Driver	Integrated
Dimming type	Dimmable Push
Batteries inside	No

Ecodesign and Energy Labelling

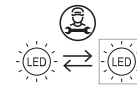

Replaceable (LED only)
light source by a
professional

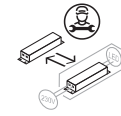

Replaceable control
gear by a professional

Spare Parts

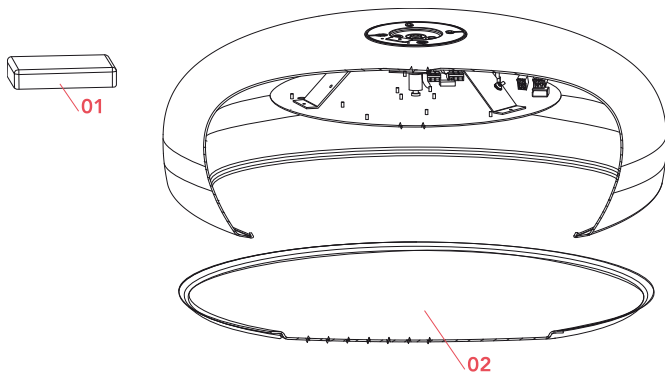

02. Methacrylate diffuser

RF19022

DOWNLOAD



RF19022

Methacrylate diffuser