

a

emotional light

caos collection

LED

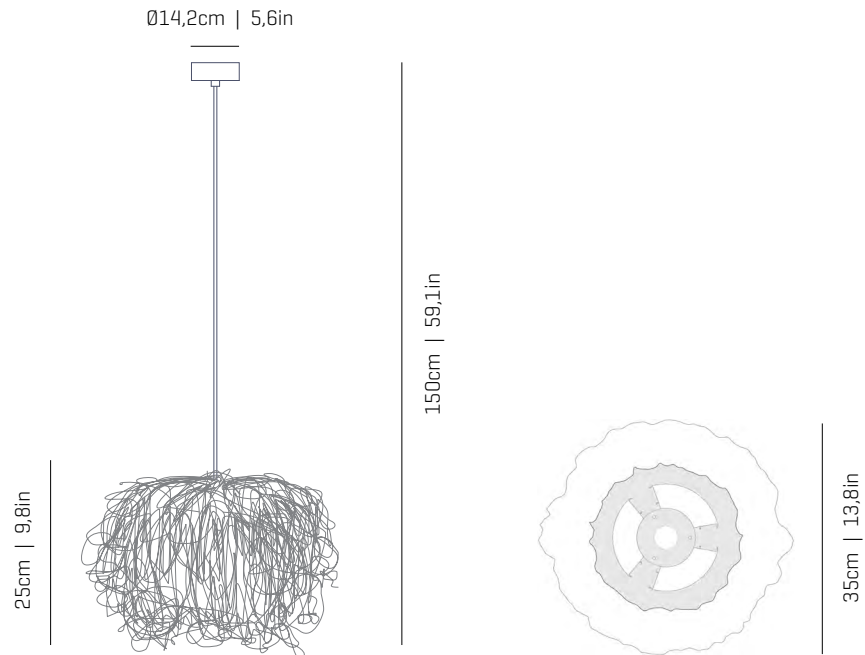

ref. CA04B-LD



MATERIALS & COMPONENTS | MATERIALES & COMPONENTES

LAMP SHADE | TULIPA

Cord | One color to choose
Cordón | Un color a elegir

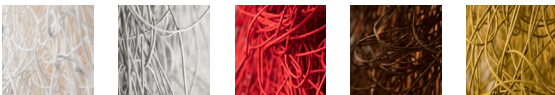

42 43 46 47 48

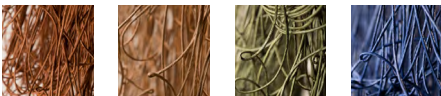

49 50 51 52

Stainless steel Acero inoxidable

Bottom diffuser Difusor inferior

CANOPY AND CABLE | FLORÓN Y CABLE

Steel gloss nickel-plated
Acero níquel-satinado

Transparent or black cable
Cable transparente o negro

Standard: 150cm | 59,1in
Length/largo customizable
120V: 200cm | 78,7in

LIGHT SOURCE BUILT IN

FUENTE DE LUZ INCLUIDA

230V - 50Hz

17W 2700K 1645lm built-in
upon request 3000K 1776lm

Dimming system: PHASE CUT
upon request DALI / Switch DIM

100-277V - 60Hz

17W 2700K 1645lm built-in
upon request 3000K 1776lm

Dimming system: PHASE CONTROL &
(only 120Vac TRIAC Dimmers)

ENERGY EFFICIENCY

EFICIENCIA ENERGÉTICA

This product contains a light source of energy efficiency class D
Este producto contiene una fuente luminosa de la clase de eficiencia energética D

OTHER DATA | OTROS DATOS

NET WEIGHT | PESO NETO

1,7kg | 3,7lb

PACKAGING | EMBALAJE

36x36x30cm | 14,2x14,2x11,8in
2kg | 4,6lb

ELECTRICAL FEATURES

CARACTERÍSTICAS ELÉCTRICAS



CERTIFICATIONS

CERTIFICACIONES

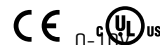

Caos

ref. CA04B-LD

Suitable for indoor use, at 25°C

Apta para uso interior a temperatura ambiente de 25°C

Box contains | Contenido de la caja:

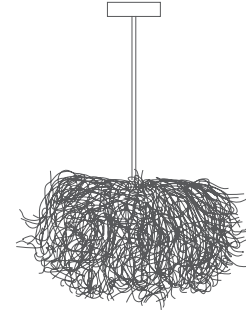
A - Lampshade | Tulipa [1]**B** - Holding piece | Pieza de sujeción [1]**C** - Security screws | Tornillos de seguridad [2]**D** - Wall Plugs | Tacos [2]**E** - Canopy | Florón [1]**F** - Screws | Tornillos [2]

LED

PHASE CUT



This product contains a light source of energy efficiency class **D**
Este producto contiene una fuente luminosa de la clase de eficiencia energética **D**

SAFETY NOTE: Switch off mains supply before commencing installation

INDICACIÓN DE SEGURIDAD: Desconecte la alimentación eléctrica antes de empezar con la instalación

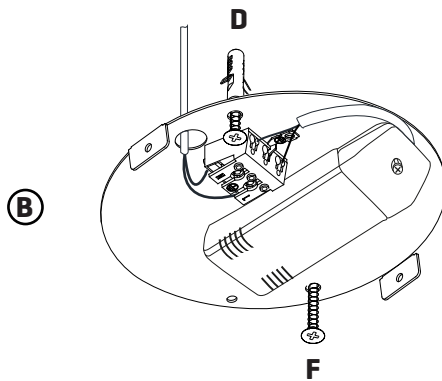

1

Drill the holes in the ceiling and fit the wall plugs into them.
Pass the electric cables to the interior and tighten the set screws [F].

Realizar los agujeros en el techo y colocar los tacos.
Pasar los cables eléctricos al interior y apretar los tornillos de fijación [F].

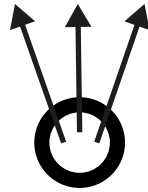
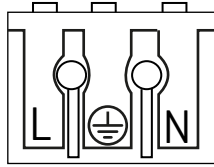

CÓDIGO DE COLORES: FASE (L) - NEGRO O MARRÓN
NEUTRO (N) - AZUL
TOMA TIERRA (⊕) - VERDE Y AMARILLO

COLOR CODE: PHASE (L) - BLACK OR BROWN
NEUTRAL (N) - BLUE
EARTHING (⊕) - GREEN AND YELLOW

2

Do the electric connection in the terminal blocks, please following the code os letters and colors indicated.

For a correct connection is important stripping wires correctly with a distance between 8-12mm.

Then press the tab opening spring and push the cable slightly.

Hacer la conexión eléctrica en la ficha de conexiones, siguiendo el código de letras y colores indicado.

Para una correcta conexión es importante pelar los cables correctamente con una distancia entre 8-12mm.

Después presione la pestaña abriendo el resorte y empuje el cable ligeramente.

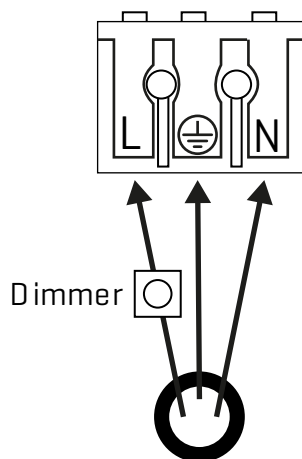

3

This luminaire includes the regulating system by the phase cut, for the power of the reduction of luminous flux, carries out the connection in the manner indicated in this step.

Esta luminaria incluye sistema de regulación por corte de fase, para poder obtener una reducción del flujo luminoso, realice el conexionado de la manera indicada en este paso.

| AC INPUT: main supply | | DC OUTPUT: LED | |
|--------------------------|-------|-------------------|-----|
| N | L | - | + |
| blue | brown | black | red |

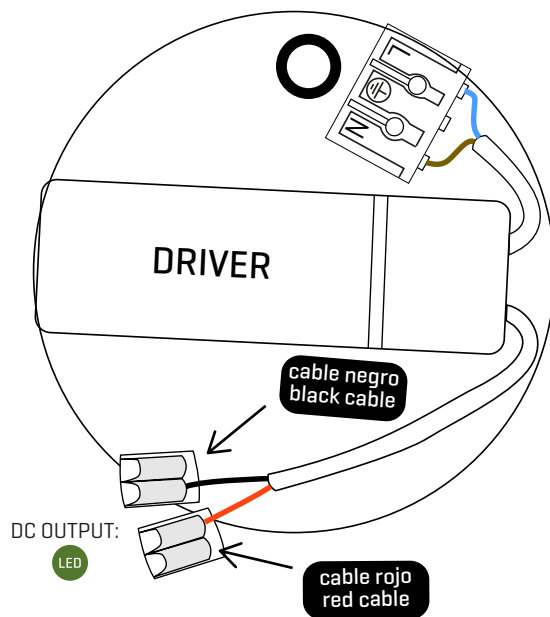

4

LED CONNECTION:

Once the light source is connected, proceed to connect the luminaire to the connection tabs, respecting the color code for low voltage:

RED WITH RED - POSITIVE

BLACK WITH BLACK - NEGATIVE

To do this, lift the free orange label and insert the cable marked with the base corresponding to the color you are connecting.

CONEXIÓN LED [luminaria]:

Una vez tenga conectada la fuente de luz, proceda a conectar la luminaria a las fichas de conexión respetando el código de colores para baja tensión:

ROJO CON ROJO - POSITIVO

NEGRO CON NEGRO - NEGATIVO

Para ello levante la pestaña naranja libre e introduzca el cable marcado con la funda correspondiente al color que esté conectando.

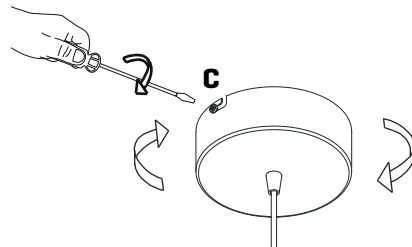
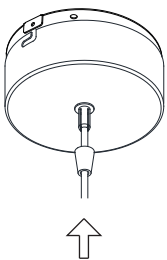

5

Insert the canopy in the holding piece and tight the security screws.

Tighten the strain relief situated on the canopy

Encajar el florón en la pieza de sujeción y apretar los tornillos de seguridad.

Apretar el tensor del cable situado en el florón.

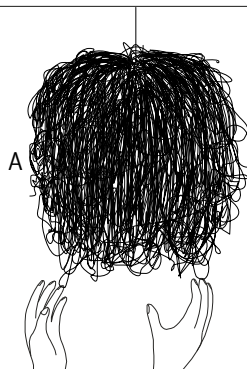

6

The lamp should be treated with care. Occasionally getting the lampshade with strength may modify its original design. To solve it, open the lampshade and mold with your hands all the crushed parts so that they recover their original shape.

Debido a la flexibilidad del material, al manejar la tulipa se puede modificar su diseño original. Para solucionarlo, moldear con la mano las zonas donde se aplaste para que vuelvan a su posición original.

Caos

ref. CA04B-LD

Suitable for indoor use, at 25°C

Apta para uso interior a temperatura ambiente de 25°C

Box contains | Contenido de la caja:

A - Lampshade | Tulipa [1]

B - Holding piece | Pieza de sujeción [1]

D - Security screws | Tornillos de seguridad [2]

E - Wall Plugs | Tacos [2]

F - Canopy | Florón [1]

G - Screws | Tornillos [2]

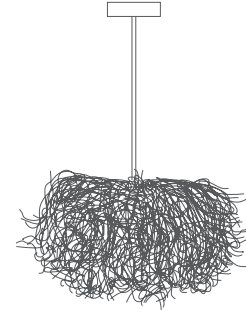

LED

This product contains a light source of energy efficiency class **D**
Este producto contiene una fuente luminosa de la clase de eficiencia energética **D**



SAFETY NOTE: Switch off mains supply before commencing installation

INDICACIÓN DE SEGURIDAD: Desconecte la alimentación eléctrica antes de empezar con la instalación

| | | |
|------------|---|--|
| <p>1.1</p> | <p>See the circuit diagram on the back of this sheet</p> <p>Ver diagrama de circuito en el reverso del folio</p> <p>1.2</p> | <p>1</p> <p>1.1 Drill the holes in the ceiling, fit the wall plugs into them and screw the holding piece.</p> <p>1.2 Do the electric connection, please follow the instructions.</p> <p>1.1 Realizar los agujeros en el techo, colocar los tacos y atornillar la pieza de sujeción.</p> <p>1.2 Hacer la conexión eléctrica siguiendo las instrucciones.</p> |
|------------|---|--|

| | |
|----------|--|
| <p>A</p> | <p>2</p> <p>The lamp should be treated with care. Occasionally getting the lampshade with strength may modify its original design. To solve it, open the lampshade and mold with your hands all the crushed parts so that they recover their original shape.</p> <p>Debido a la flexibilidad del material, al manejar la tulipa se puede modificar su diseño original. Para solucionarlo, moldear con la mano las zonas donde se aplaste para que vuelvan a su posición original.</p> |
|----------|--|

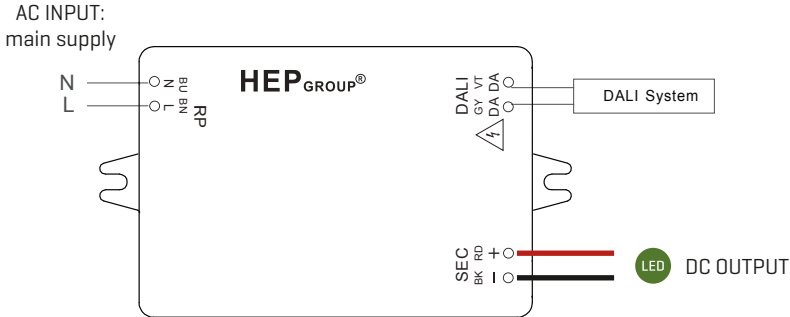

Circuit diagram DALI

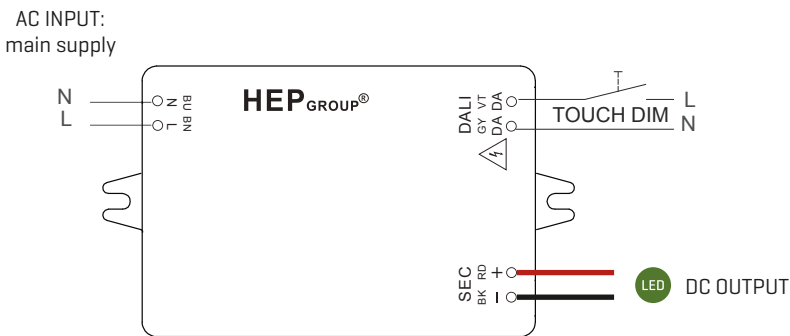

Circuit diagram TOUCH DIM

Touch Dim

Short push (< 0.6 sec)
Long push (> 0.6 sec)

Push to turn ON-OFF
Dimming up or down

Synchronization of a large number of driver of Touch Dim

- | | | |
|----------|------------|---|
| 1. Step: | Long push | All the lamps are switched on |
| 2. Step: | Short push | All the lamps are switched off |
| 3. Step: | Long push | All the lamps are switched on the minimum dimming setting of the drivers and continuously |

Fade up to the desired dimming level, then release push button.

Max. 15pcs parallel units

| AC INPUT: main supply | | DC OUTPUT: LED | | Dimming control | |
|--------------------------|-------|-------------------|-----|-----------------|--------|
| N | L | - | + | - | + |
| blue | brown | black | red | grey | purple |

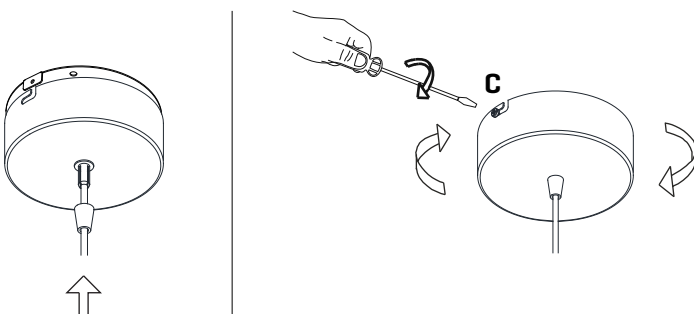

3

Insert the canopy in the holding piece and tight the security screws.
Tighten the strain relief situated on the canopy

Encajar el florón en la pieza de sujeción y apretar los tornillos de seguridad.
Apretar el tensor del cable situado en el florón.