

# Artemide®

## nh

design  
Neri & Hu

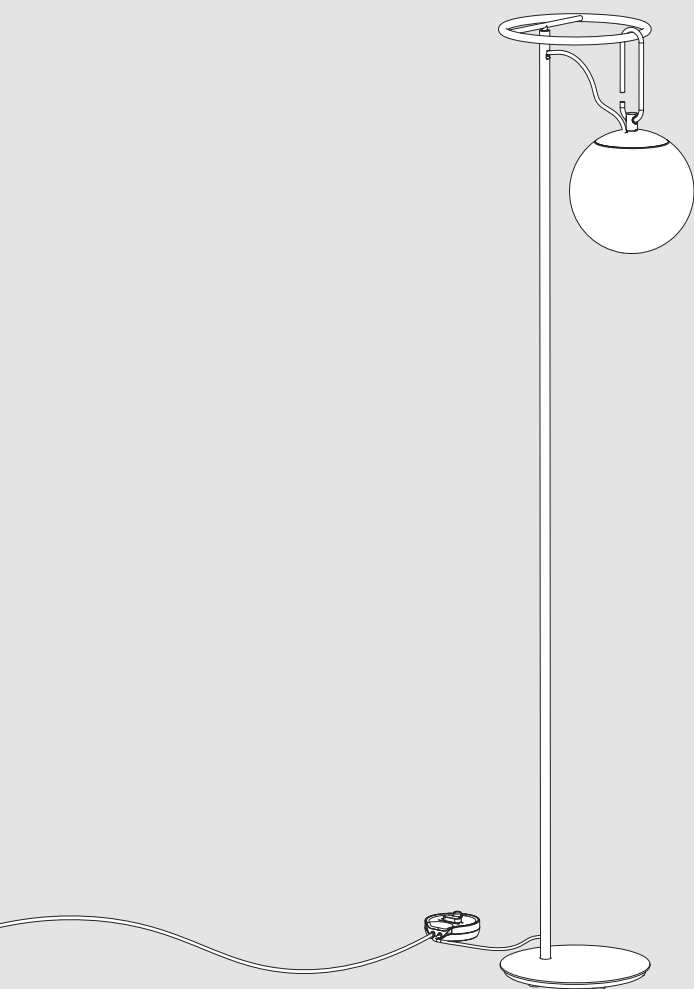

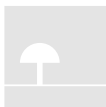

i

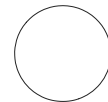
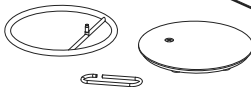
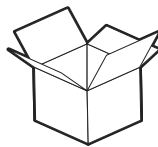
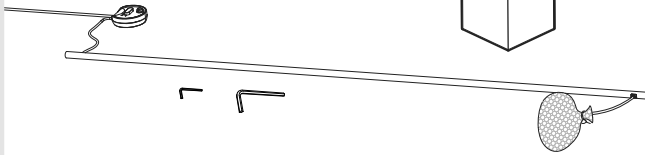
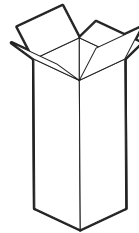
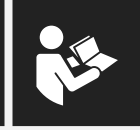
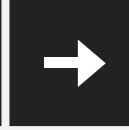
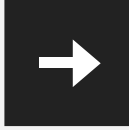
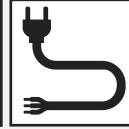
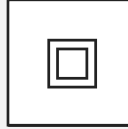

**i**

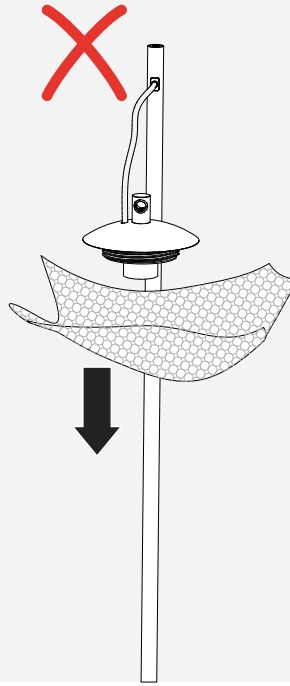
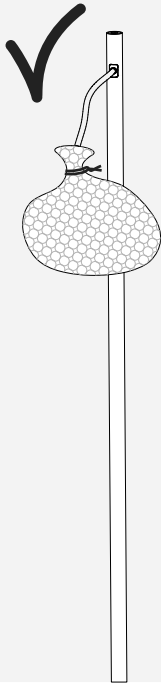

**1**

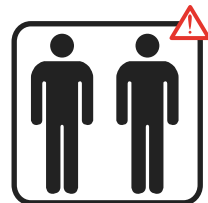
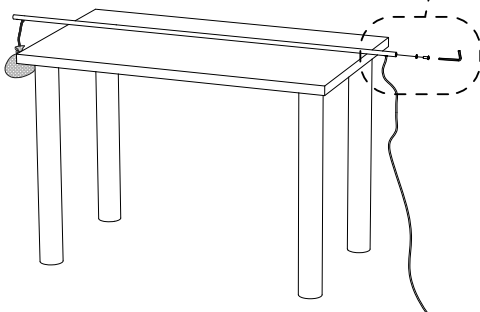
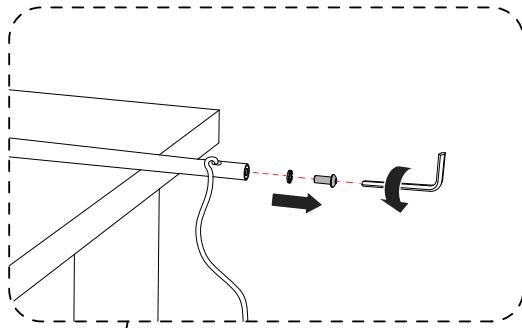

2

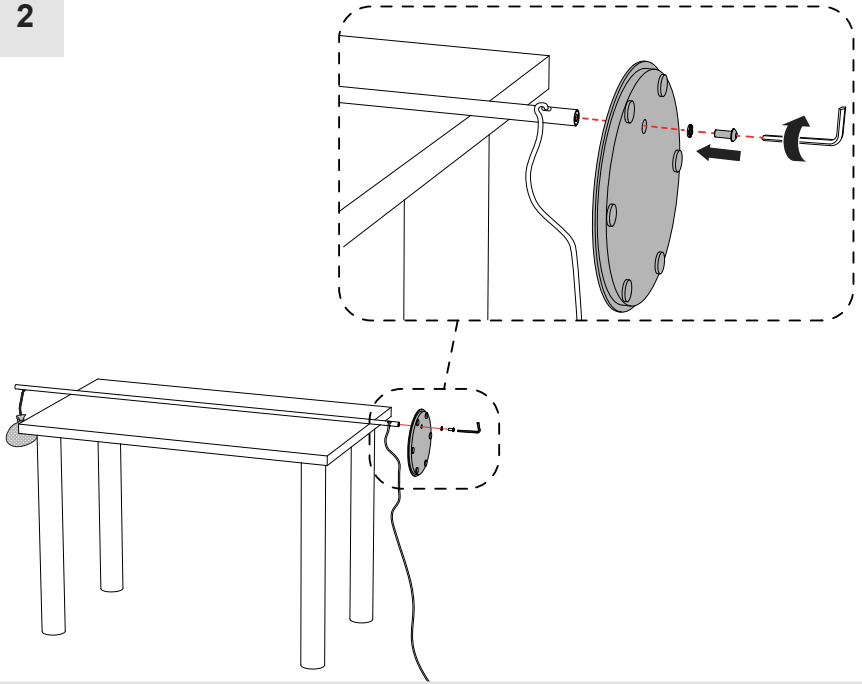

3

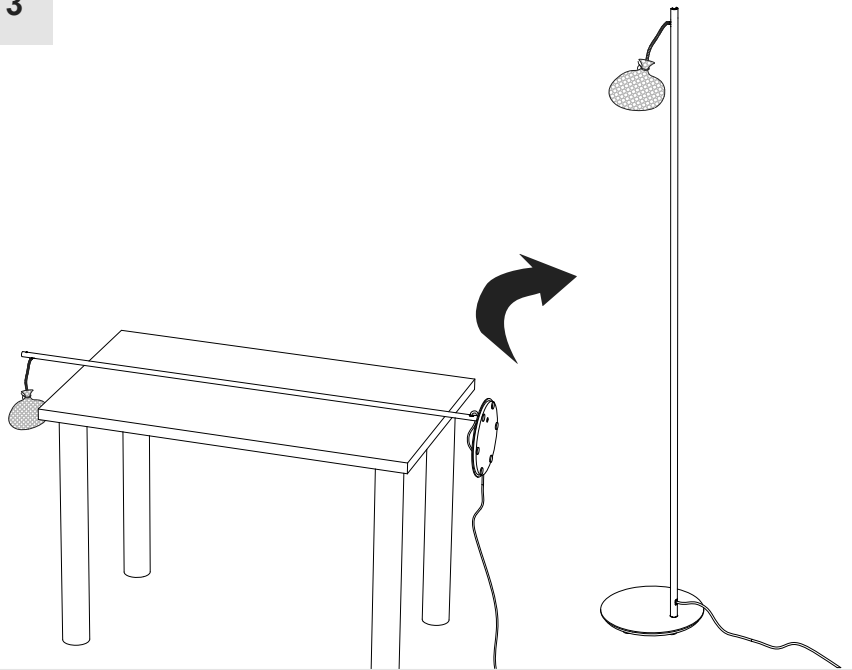

4

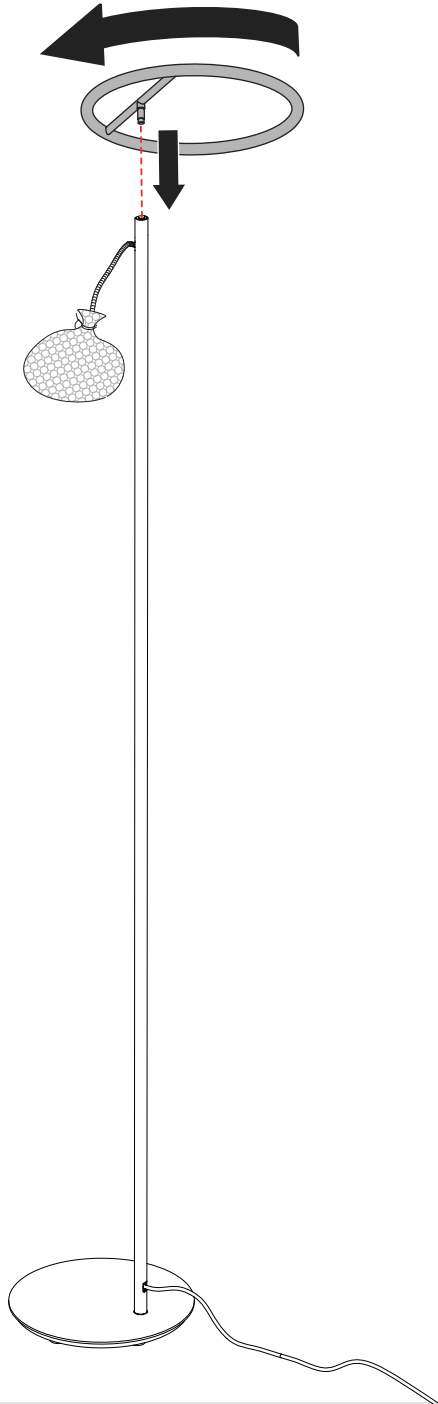

5

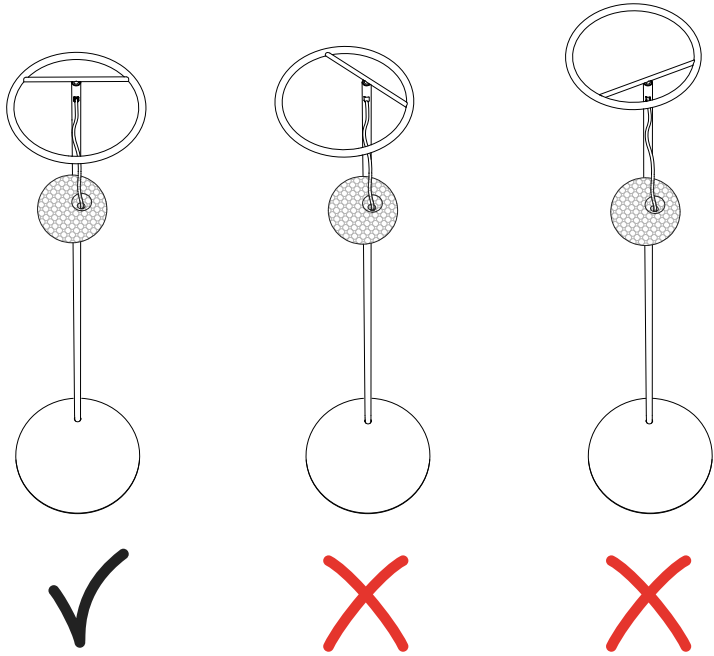

6

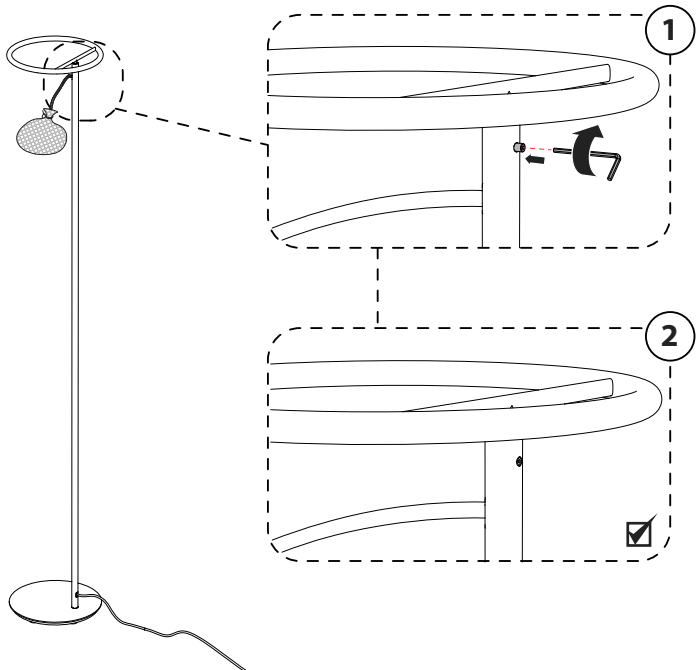



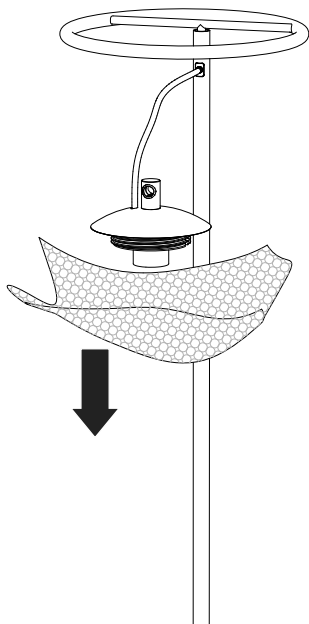

7

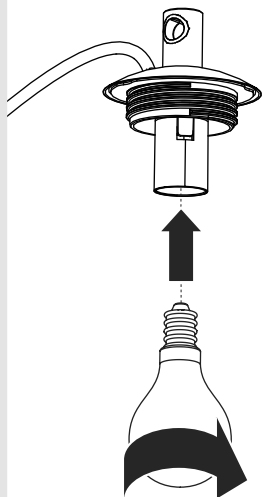

8





-   
LED
-   
HALO
-   
HALO
-   
FLUO

**E27 - MAX 15W LED**

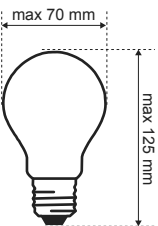

For USA and Canada only

**E26 - MAX 15W LED  
cULus SBLED**

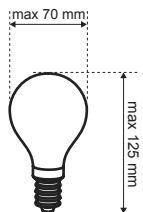

9

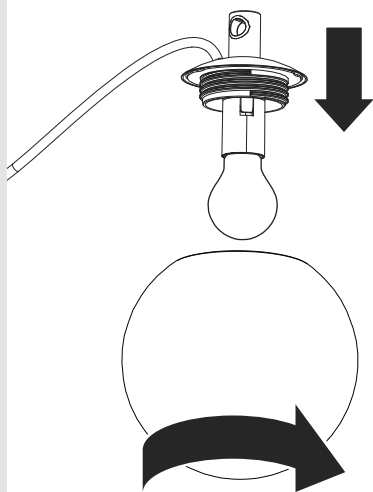

10

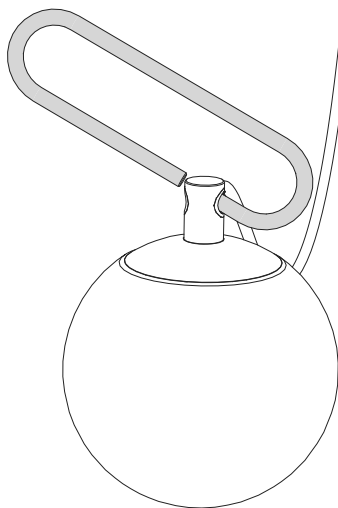

11

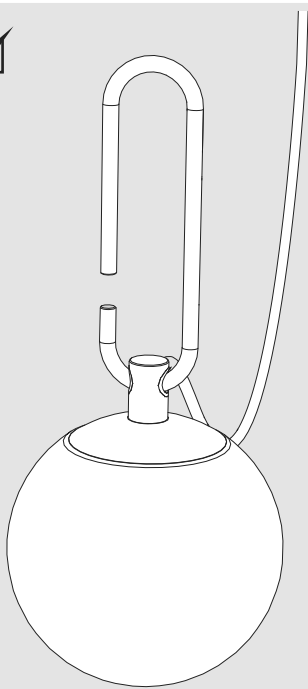
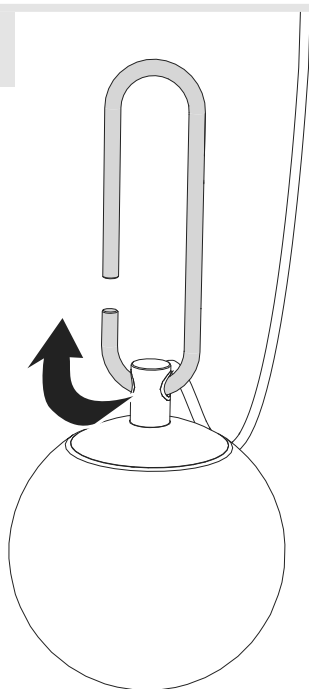



12

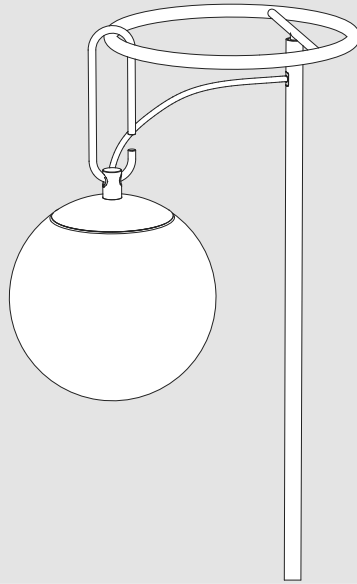
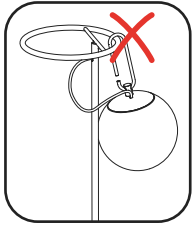
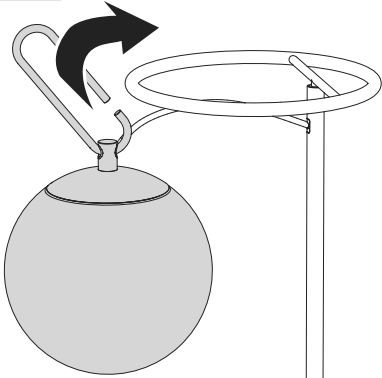

13

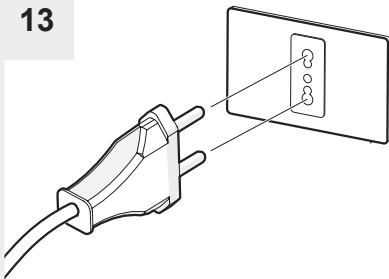

For USA and Canada only

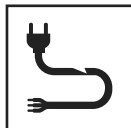
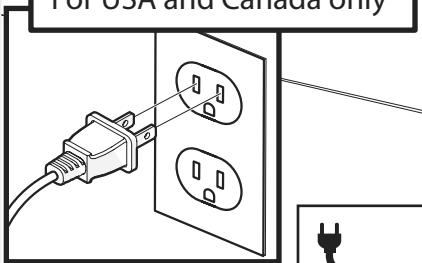

14

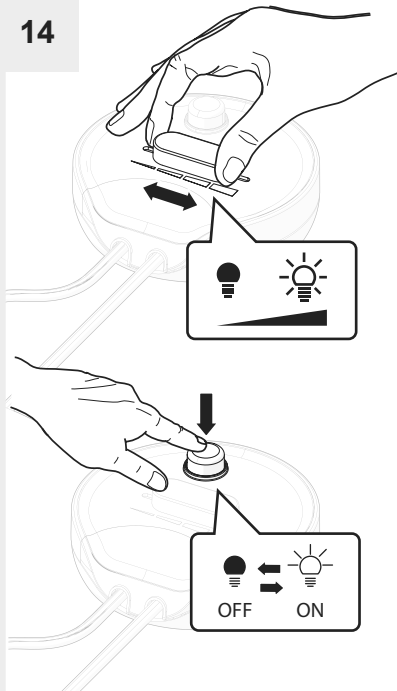

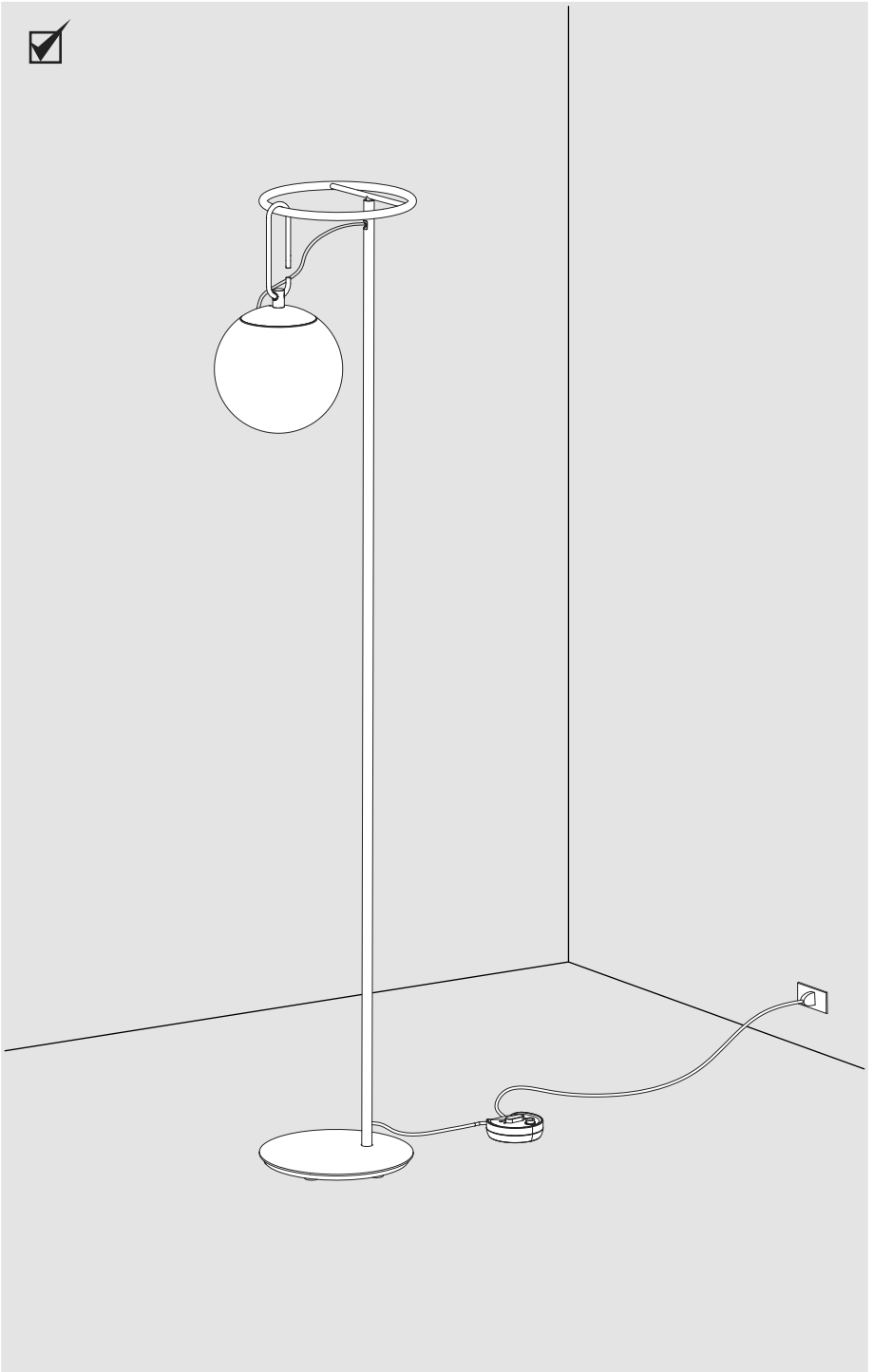

i

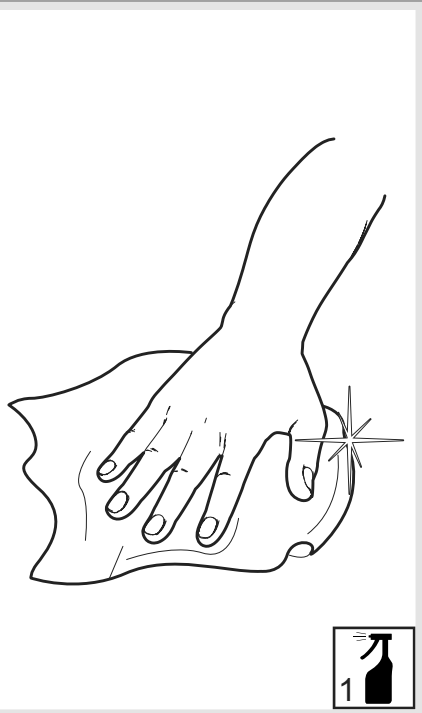
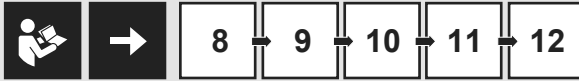
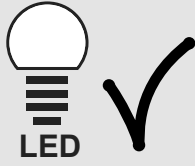

**Artemide®**

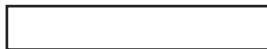

## **Artemide**

via Bergamo, 18  
20010 Pregnana M.se (MI)  
ITALIA

tel. +39 02 935 181  
fax +39 02 935 90 254  
fax +39 02 935 90 496

[www.artemide.com](http://www.artemide.com)

VAT IT00846890150

cod. Y513001199