

# Artemide®

## MEZZACHIMERA

design  
Vico Magistretti

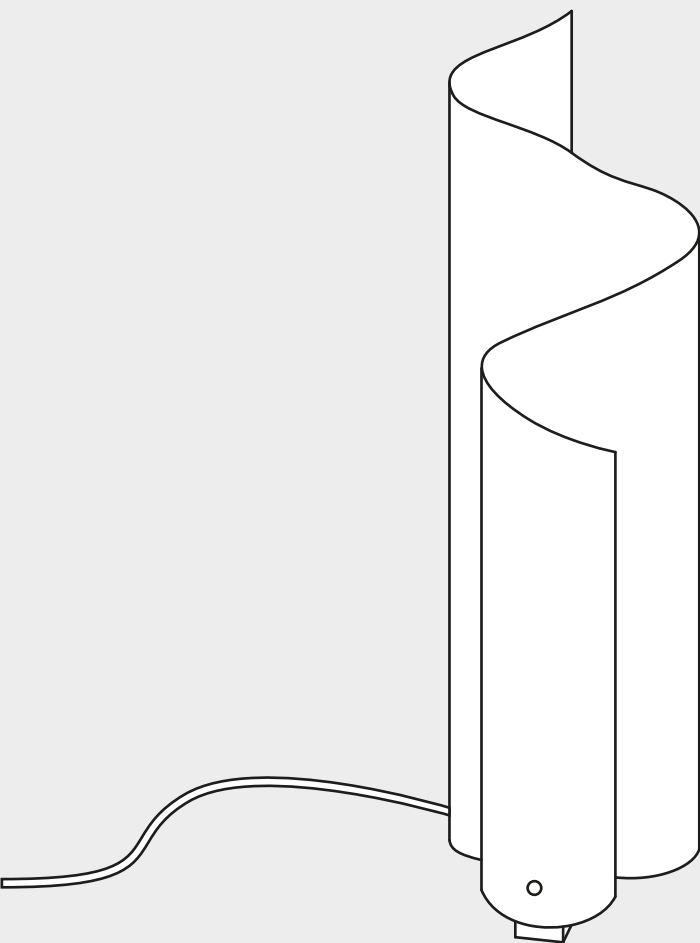



i

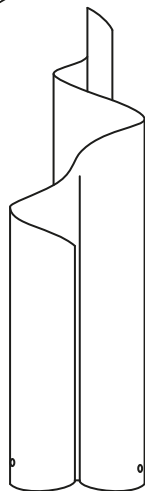
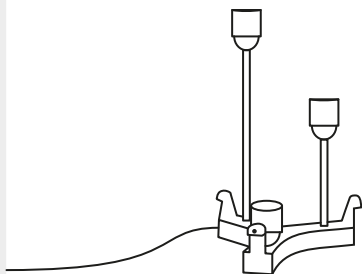
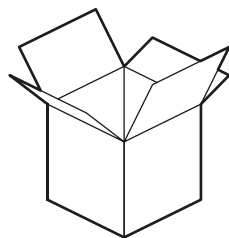
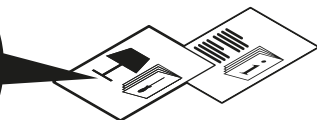
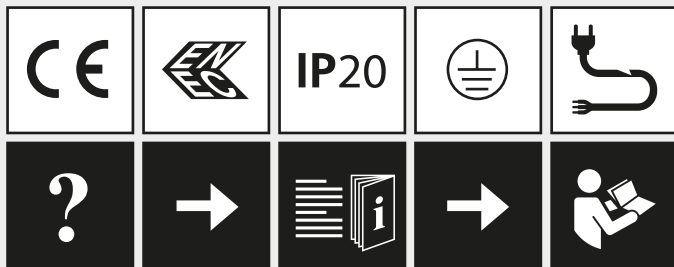

1

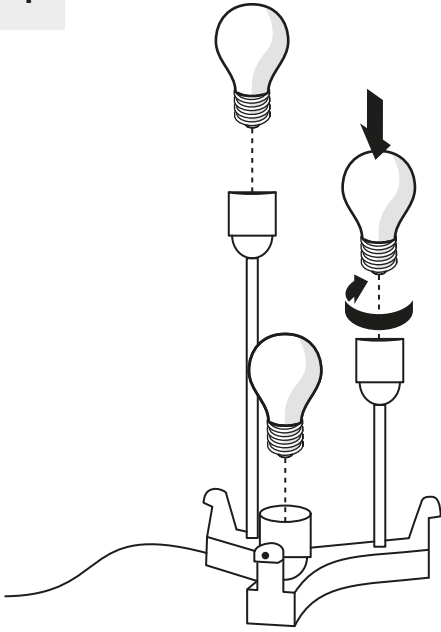

- 3x 46W Halo (E27)
- 3x 9W LED RETROFIT (E27)

**For USA and Canada only:**

- 3x MAX 46W (E26)
- 3x MAX 9W (E26)  
cULus SBLED

2

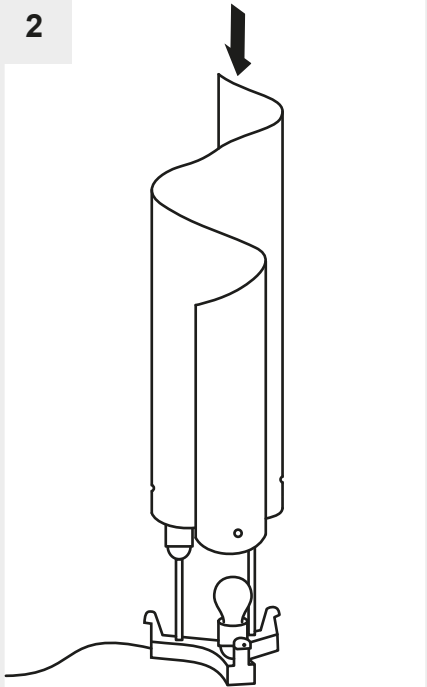

3

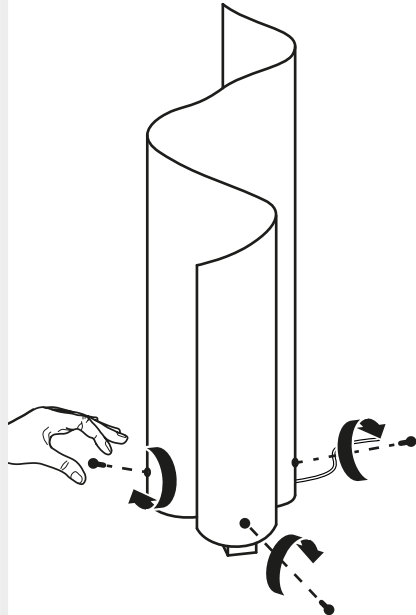

4

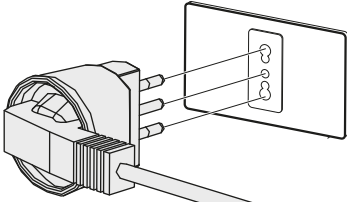

For USA and Canada only

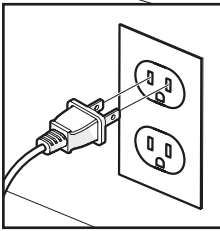

5

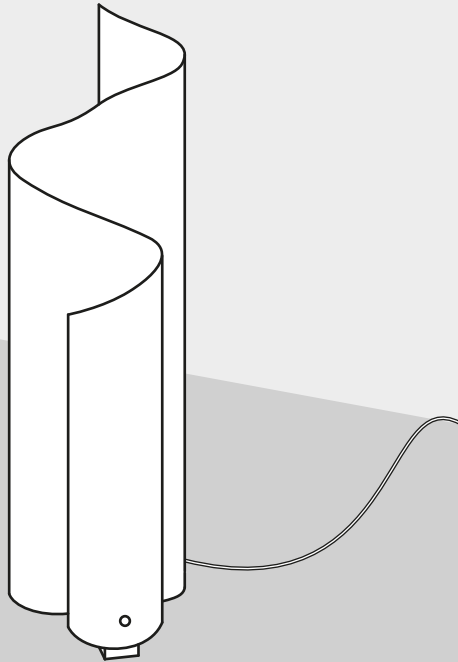
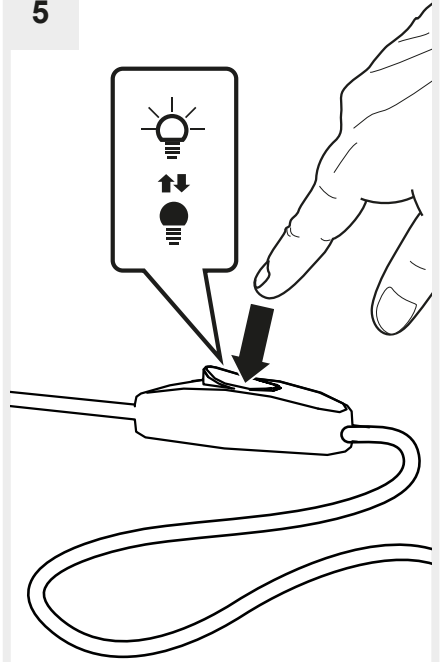

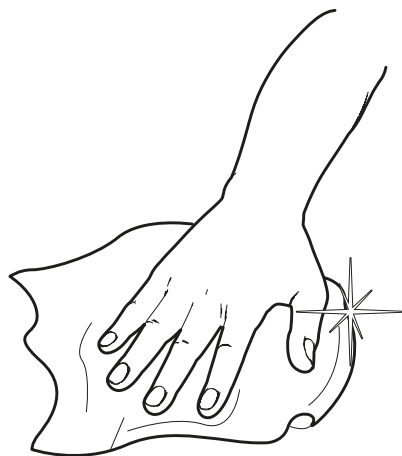
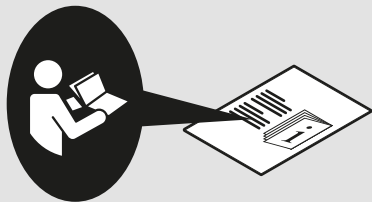





# Artemide®



## **Artemide**

via Bergamo, 18  
20010 Pregnana M.se (MI)  
ITALIA

tel. +39 02 935 181  
fax +39 02 935 90 254  
fax +39 02 935 90 496

[www.artemide.com](http://www.artemide.com)

VAT IT00846890150

## **Artemide Inc.**

250 Karin Lane  
Hicksville, NY 11801

tel. 631 694 9292  
Toll Free 1-877-Art-9111  
Fax 631 694 9275

[www.artemide.net](http://www.artemide.net)

## **Artemide Ltée/Ltd.**

11105 rue Renaude Lapointe  
Montréal, Québec H1J 2T4

Tel. 514 323 6537  
Toll Free 888 777 2783  
Fax 514 323 8864

[www.artemide.net](http://www.artemide.net)

cod. Y513000588